

download this zine  
for free at  
companion website

Contact  
aaron  
→ <http://bikecart.pedalpeople.com>  
[bikecart@riseup.net](mailto:bikecart@riseup.net)

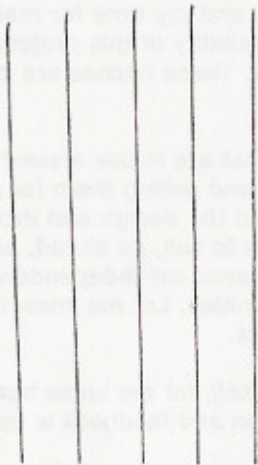

To:

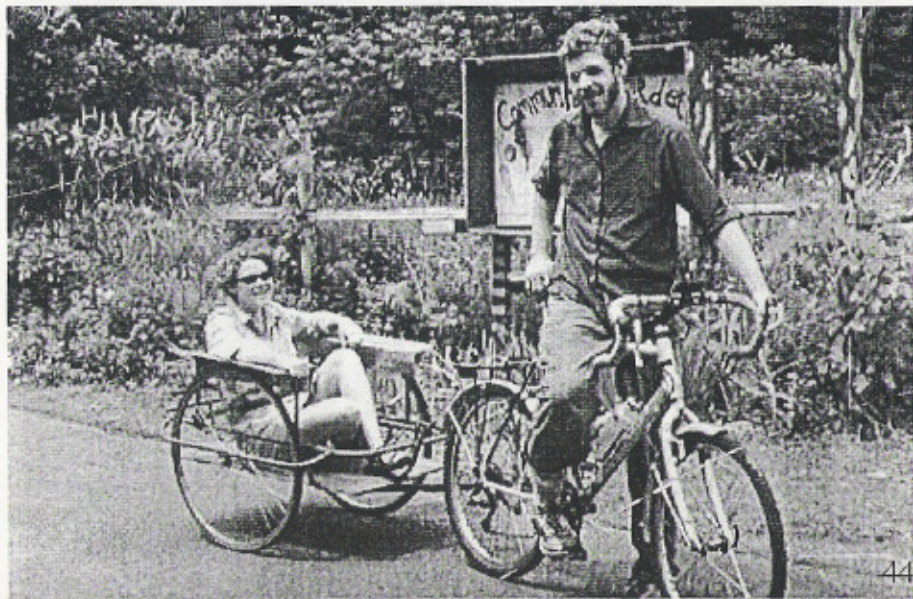

# Community Bike Cart Design

april 12, 2005

aaron  
forest - Wieler

a bicycle trailer with a 200 lb capacity that's cheap  
and easy to build with basic tools and materials  
--for car independence and community--

\$30 in parts, 8 to 15 hours to build





## Assembly Diagram

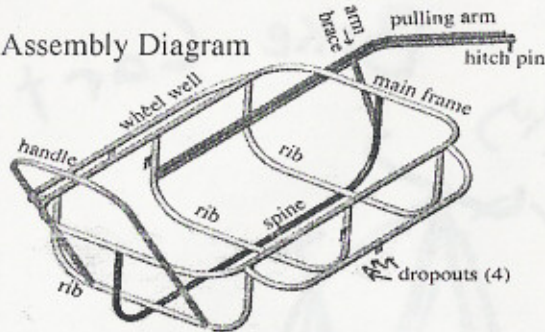

I design and build bicycle trailers because I want to create alternatives to automobile use. I am critical of the current paradigm, and I see hope in localizing the provision of technology. One way to increase the accessibility of using bicycles instead of cars for moving cargo is to provide a low cost means to move materials around by bike. This cart is functional, relatively easy to build, and cheap. The parts cost about \$30 if you can find bicycle wheels and plywood for free, and it takes from 8 to 15 hours to build a finished trailer.

As a society, we use automobiles without questioning or evaluating their real environmental and social impacts and costs. The issues go farther than gasoline cost and greenhouse gas emissions, to the globalization and outsourcing of manufacturing and the raw material, pollution, and energy costs of industrialism. Our political system perpetuates the militarization of petroleum-rich parts of the world by the countries that use the most oil. This technology is driven by a desire for community-based social change.

page

### Contents

3	overview and fabrication breakdown
5	parts and tool list
7	using the cart
10	glossary
13	using the tools

#### fabrication of the cart

14	cutting and bending tubes and dropouts
19	mitering the tubes for brazing/welding
20	aligning the frame for brazing/welding
21	brazing/welding frame together
24	creating the dropout jig
25	adding wheel wells and dropouts
28	creating the pulling arm
29	hitch creation
31	finishing the cart

#### some modifications

33	"deep and long" (6 foot cart)
35	bolt-together design (no welding)
39	more information (links, photos, buying a cart)

please distribute freely. some rights reserved: creative commons "Attribution-ShareAlike 2.0" license. you can copy, use commercially, change, and redistribute this work by attribution and with the same license. <http://creativecommons.org/licenses/by-sa/2.0/>

Read first, build happily, and let me know how it goes for you.

Contact info: [bikecart@riseup.net](mailto:bikecart@riseup.net)  
<http://bikecart.pedalpeople.com>

## About buying the cart

I have been working on this design since the spring of 2004. I'm hoping people will be excited about making carts for themselves, but I know some people would rather buy them. If you need a cart and can't build it, email me, and I'll try to connect you with people making carts or build you one. They should cost about \$150. Parts are \$30, and fabrication takes about 8 hours.

One of the more time consuming parts of cart fabrication is finding wheels and tires and making the plywood bed. One way to spread these bike carts might be to sell just the cart body, and let the user find and mount wheels and plywood.

If you want to make a bike cart but can't make a hitch, I will send you one for the cost of parts, postage, and my time for making it (cost is \$20 in 2005). I want to increase the accessibility of this project. For more information, contact me at [bikecart@riseup.net](mailto:bikecart@riseup.net). These hitches are compatible with Bikes At Work trailers.

I have made a few carts that are in use around where I live. I am thinking about making a few more and selling them for parts plus my time, probably for \$150, in order to spread the design and increase visibility for the project. If you want make these carts to sell, go ahead, but please include a copy of this booklet. The goal is to increase car independence and empower people through fabrication in their communities. Let me know if you sell these carts, and what you think about this project.

If you build a cart for yourself, let me know how it goes because I'm continuously working on the design and feedback is useful.

aaron and lisa working together on the bolt-together cart

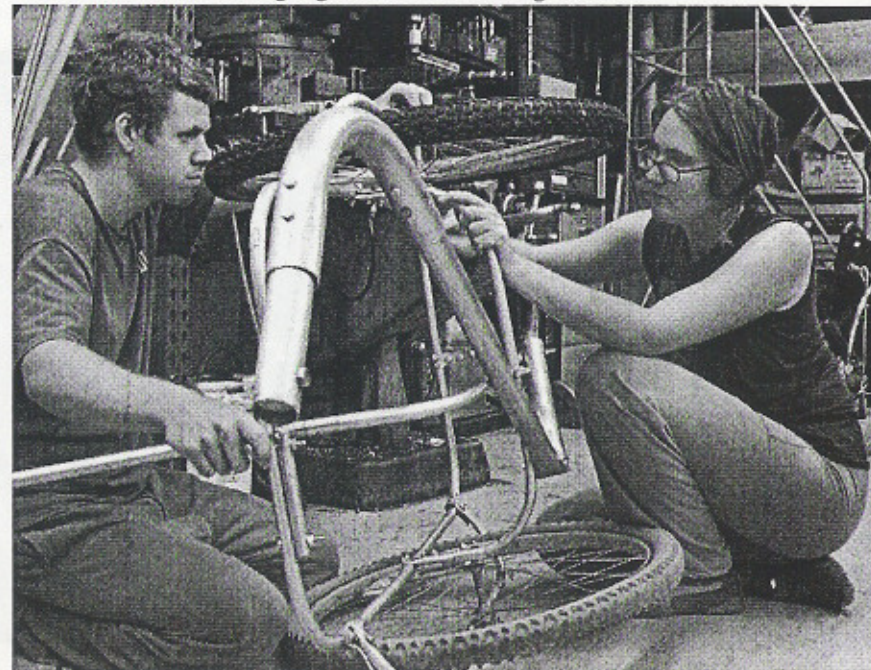



from cyclecircus.org ... another design for a weldless bike trailer. the chain in the hitch is a free version of a universal joint, but it allows the cart to tug on the bike. the design could be strengthened considerably with a little bit of welding.

# MAKE YOUR OWN WELDLESS BIKE TRAILER

## WHAT'S THE HITCH?

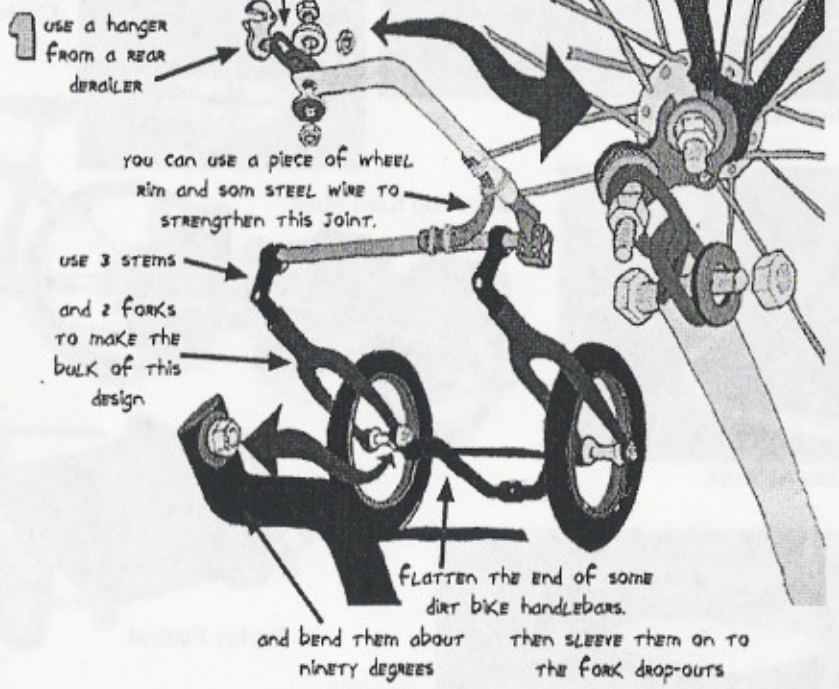

Koolstop Wilderbeast

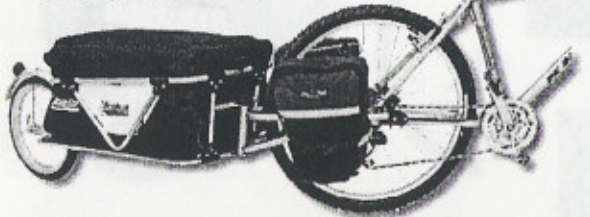

Extracycle

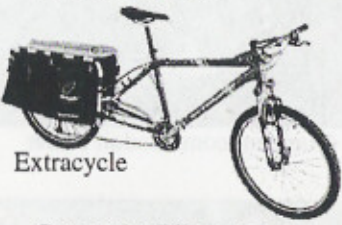

Cancart by Bikecartage



Radicaldesign Cyclone

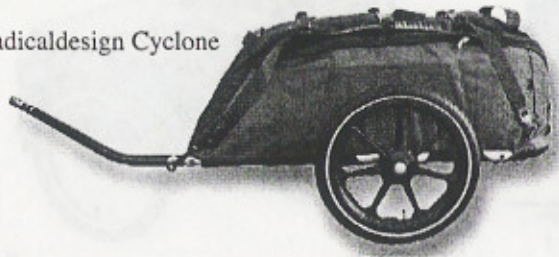

## Trailer Overview

cart is made from 5 pieces of electrical conduit

**fabrication:**  
 \*cut conduit tubes with a hacksaw  
 \*bend conduit with a conduit bender  
 \*braze with an oxy-acetylene torch  
 \*cut, bend, and braze hitch together

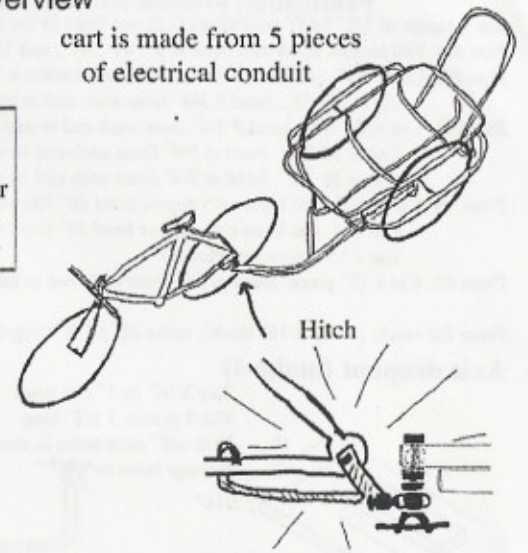

2 Wheels: find 26", 27", or 700c wheels from other bikes

Pulling Arm: 50" tube brazed to 51" tube. 45 degree bends at 10" and 11" from end, respectively. 3/8" bolt at end as pin to attach to hitch on bicycle.

2 Wheel Wells: 38 1/2" tube, bent 3/4" from each end

Arm Brace: 15" tube to brace the pulling arm

Handle: 72" tube bent 26" from ends

Spine: 59" tube, bent at 6 1/2" from ends

4 dropouts: slots for the wheel axles, made from 1" wide steel flat stock

Main Frame: 118" tube, with bends at 2", 41", 61", and 100" from one end

3 ribs: 38 1/2" tubes, bent 5 3/4" from ends

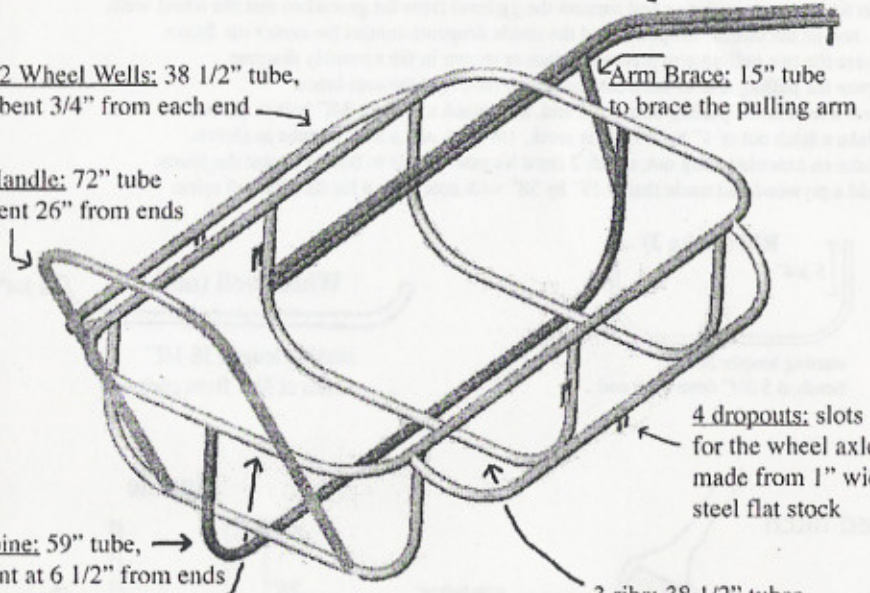



### Fabrication Breakdown (more detail on page 14)

Get 5 pieces of 1/2" EMT conduit and cut and bend in the following manner:

Pipe #1: Full length. Mark and bend at 2", 41", 61", and 100". Overlap the last 2."

Pipe #2: Cut at 59", bend 6 1/2" from each end to make a "u" (spine)

Cut at 38 1/2", bend 5 3/4" from each end to make a "u" (rib 1)

Piece #3: Cut at 38 1/2", bend 5 3/4" from each end to make a "u" (rib 2)

Cut at 38 1/2", bend at 3/4" from each end to make a "u" (wheel well 1)

Cut at 38 1/2", bend at 3/4" from each end to make a "u" (wheel well 2)

Piece #4: Cut at 50", and bend a 45 degree bend 10" from end (bottom pulling arm)

Cut 51", and bend a 45 degree bend 11" from end (top pulling arm)

Cut a 15" piece (arm brace)

Piece #5: Cut a 72" piece. Bend at 26" from each end to make a "u" (handle)

From flat stock: (1" by 3/16" thick), make (4) 1 1/2" long dropouts with a 3/8" slot.

### Axle dropout (make 4)

Use 3/16" by 1" flat stock  
Cut 4 pieces, 1 1/2" long  
Drill 1/8" pilot holes in centers  
Enlarge holes to 3/8"

Spine

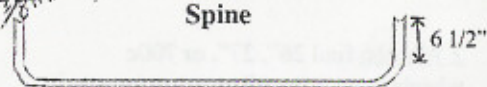
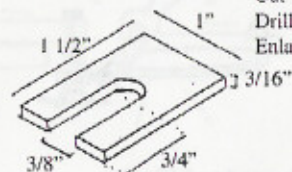

starting length: 59"  
bends at 6 1/2" from each end

\*Miter the ends of the tubes with a file to fit as shown in the assembly diagram.

\*Braze the main-frame, ribs, and spine together.

\*Make a dropout jig, each set of dropouts is 4" apart, and space the sets at 22 1/2".

\*Put the dropouts in the jig and support the jig level from the ground so that the wheel wells rest on the outside dropouts, and the inside dropouts contact the center rib.

\*Braze the two pulling arm pieces together as shown in the assembly diagram.

\*Braze the pulling arm to the front and center ribs. Add the arm-brace.

\*Drill a hole in the pulling arm at the end, and attach a 2" long 3/8" bolt as shown.

\*Make a hitch out of 1" by 3/16" flat stock, 1/4" rod, and a 3/8" ID tube as shown.

\*Make an extended wing nut, attach 2 front bicycle wheels to the cart, paint the joints.

\*Add a plywood bed made that is 19" by 38" with notches cut for the ribs and spine.

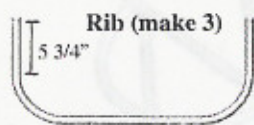

starting length: 38 1/2"  
bends at 5 3/4" from each end

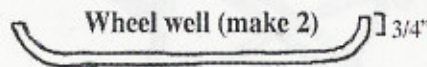

starting length: 38 1/2"  
bends at 3/4" from each end

### bolted hitch

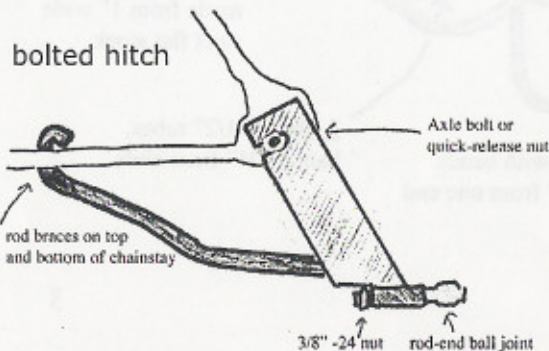

### Handle

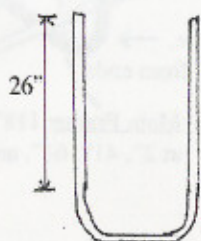

starting length: 72"  
bends at 26" from ends

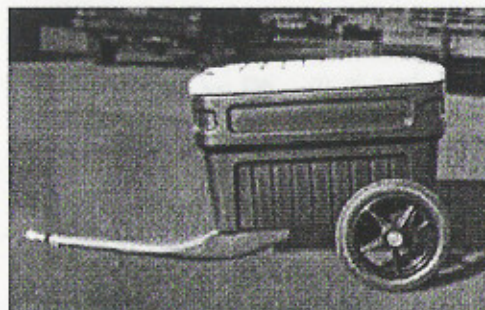

BicycleR Evolution Shopper



Bob Yak

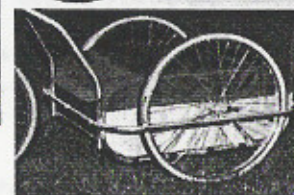

CycleTote



Bikes At Work

### Koolstop Kool Mule

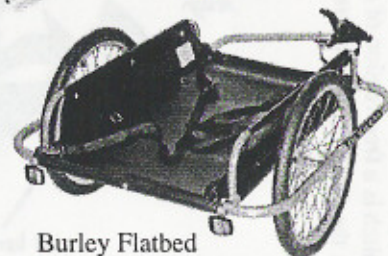

Burley Flatbed

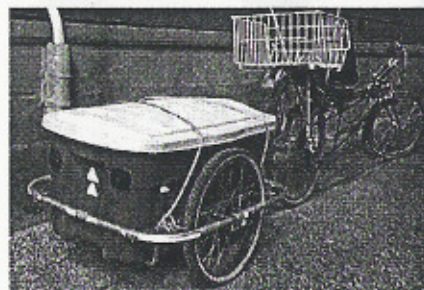

drumbent.com conduit trailer

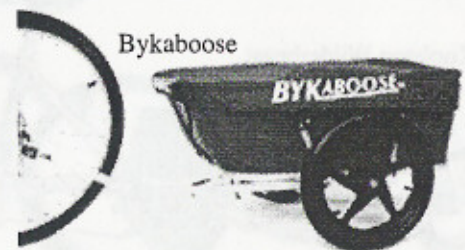

Bykaboose

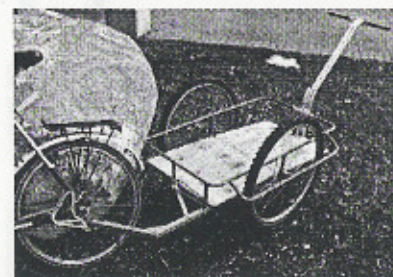

my first prototype



Burley Nomad



## Photos

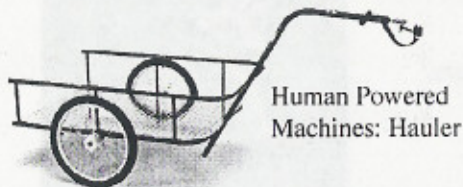

Human Powered  
Machines: Hauler



I-bike trailer

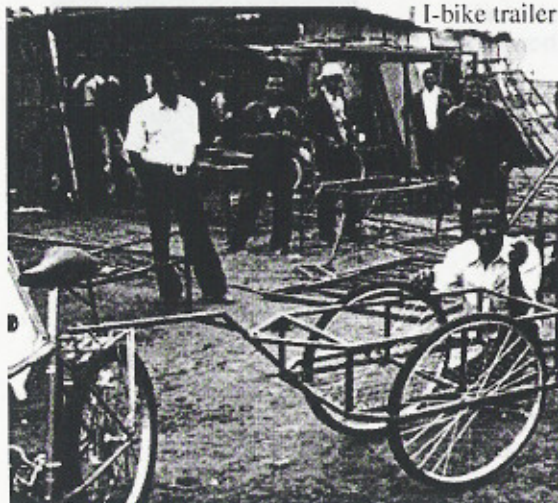

Karstilo trailer



Bikes at Work

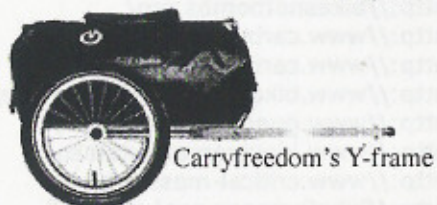
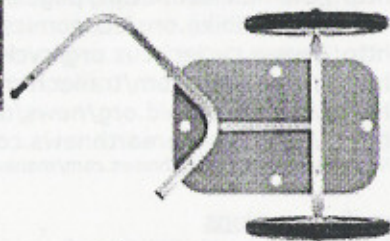

Carryfreedom's Y-frame

## Parts List for Trailer and Hitch

Trailer and hitch (1 cart) **\$31**

Trailer and hitch (4 carts) **\$25**

All parts from local hardware store except rod end ball joint, which is part # 6072K64 at McMaster-Carr

### Trailer Body

Quantity	Cost/each	Cost for 1 cart	Cost per cart for four carts
10' 1/2" EMT conduit	5	\$3.00	\$15.00
1/2" EMT coupling	1	\$0.35	\$0.35
3/16" X 1" bar, 48" long (makes trailers)	1	\$5.00	\$5.00
3/8"-16 X 2" long bolt.	2	\$0.20	\$0.40
3/8" -16 nut	3	\$0.08	\$0.24
3/8"-16 wing nut	1	\$0.43	\$0.43
<b>trailer subtotal</b>		<b>\$21</b>	<b>\$18</b>

### Bolt-Through Hitch

1/4" rod, 3' or 4' (8" per cart)	1	\$1.99	\$1.99	\$0.50
rod end ball joint (zinc plated, oiled bronze 3/8"-24)	1	\$5.92	\$5.92	\$5.92
3/8" - 24 nylon nut (or regular nut for locking nut)	1	\$0.22	\$0.22	\$0.22
3/8" threaded female coupler, 1 1/2" long (2 hitches) (uses 3/16" X 1" bar from trailer body)	1	\$1.69	\$1.69	\$0.85
<b>bolt hitch subtotal</b>		<b>\$9.82</b>	<b>\$7.48</b>	

### Jig for Dropouts (use for future carts)

3/8" -16 threaded rod, 3 feet long	1	\$2.49	\$2.49
3/8" -16 nylon insert nuts	4	\$0.22	\$0.88
3/8" wing nuts	4	\$0.43	\$1.72
3/8" washers	8	\$0.08	\$0.64
<b>dropout jig total</b>		<b>\$5.73</b>	

### Miscellaneous and can be found for free

plywood for bed: 5/8" or 3/4" thick, 9" x 38" (and 6 pipe straps)

exterior paint that works for metal

two 26" wheels (also works: 700c or 27")

### Pulling arm

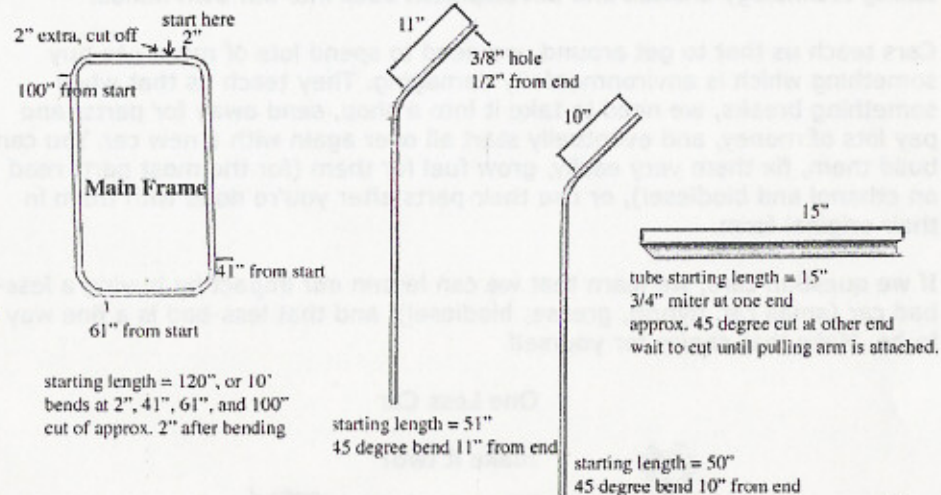



## Overview: bike carts are political

This is a manual for making bike carts. I've been designing carts that people can build in their communities for a low cost, with only basic fabrication skills and access to common tools. Through making carts, people can build community, and extend that community farther by starting community cart programs, in which a lot of people can use a few carts/bikes. The carts are built from metal conduit tubing and are brazed together using an oxy-acetylene torch. They take from 8 hours to 15 hours to make, depending on your familiarity with the fabrication techniques. They cost about \$30 to build if you use new parts and salvaged wheels.

Car Independence: We need to become independent from using our automobiles, for many reasons. Cars are a problem because they support global industrial capitalism and the outsourcing of manufacturing to the people who are hurt the worst by industrialism. They also support militarization of oil-rich areas of the world for access to cheap energy. Our use of cars releases greenhouse gases into the atmosphere, and burns dirty fuel in inefficient engines where the combustion byproducts poison humans, other organisms, and the land. Additionally, the automobile paradigm takes us out of small centralized communities where we could work, live, and play, and spreads us out to the far reaches of sprawling development where we use our cars to go everywhere and isolate ourselves from our neighbors, local small businesses, and family.

Why bike carts? Too often people complain that they would ride a bike except they can't carry what they need for work, that they can't bring their children, that they have to pick up a bag of potting soil that they couldn't possibly fit on their bike with the groceries...sound familiar? Bike carts are a great solution, but most are expensive (for a cart that can haul 200 pounds, \$300 to \$500 USD). This cart weighs 30 pounds, costs \$30 to build, and will carry more weight more securely than many commercial bike carts. It might even be able to carry larger items (like sofas or plywood, for example) than a car can carry. So this is a zine about making bike carts, but it's also about finding a way to gain independence from our cars, build community by fabricating, playing, and biking together. Reclaim transportation technology and empower ourselves by taking technology choices and development back into our own hands.

Cars teach us that to get around, we need to spend lots of money to buy something which is environmentally damaging. They teach us that when something breaks, we need to take it into a shop, send away for parts, and pay lots of money, and eventually start all over again with a new car. You can't build them, fix them very easily, grow fuel for them (for the most part: read on ethanol and biodiesel), or use their parts after you're done with them in their original form.

If we question cars, we learn that we can lessen our impact by buying a less-bad car (small car, hybrid, grease, biodiesel), and that less-bad is a fine way to be. Make that choice for yourself.

One Less Car



make it two?

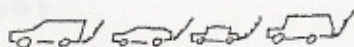

## Links

### other bike trailers

#### commercial bike carts:

<http://www.bikesatwork.com/bike-trailers/>  
<http://blueskycyclecarts.com/>  
<http://www.burley.com/>  
<http://www.bobgear.com/>  
<http://www.bykaboose.com/>  
<http://www.efn.org/~equinox>  
<http://www.bikerev.com/>  
<http://koolstop.com/trailers/beast.html>  
<http://www.xtracycle.com/html/home.php>  
<http://www.wdi.co.uk/miklink/>  
<http://www.cycletote.com/>  
<http://www.karstilo.net/bike/trailer/index.php>  
<http://bikecartage.com/> (broken link)  
<http://www.radicaldesign.nl/>  
<http://www.biket trailer.com/>  
<http://www.bikesandtrailers.com/>  
<http://www.missioncycles.co.uk/>  
<http://www.efn.org/~cat/hpm/>

#### home made bike carts:

<http://home.clear.net.nz/pages/joecolquitt/0trailer.html>  
<http://www.ibike.org/economics/trailer.htm>  
<http://www.cyclecircus.org/cyclecircus/diy.html>  
<http://drumbent.com/trailer.html>  
<http://www.transaid.org/news/downloads/sep2003.pdf>  
<http://www.motherearthnews.com/arc/6645/>  
<http://www.motherearthnews.com/menarch/archive/issues/070/070-132-01.htm>

### carfree actions

<http://bikesnotbombs.org/>  
<http://www.carbusters.org/>  
<http://www.carsrcoffins.com/>  
<http://www.bikesatwork.com/carfree/>  
<http://www.guerillastickers.com/>  
<http://www.idontcareaboutair.com>  
<http://www.critical-mass.org/>  
<http://bikeforpeace.org/>  
<http://www.carfree.com/>  
<http://www.communitybike.org/>  
<http://www.workbike.org/>  
<http://www.worldcarfree.net/>  
<http://www.carsharing.net/>  
<http://www.kenkifer.com/bikepages/>  
<http://www.efn.org/~cat/>  
<http://www.journeytoforever.org/biofuel.html>

### metal-working and supplies

<http://www.handyharmancanada.com/TheBrazingBook/bbook.htm>  
<http://www.mcmaster.com>



aaron on his first tallbike

## Iterative design process

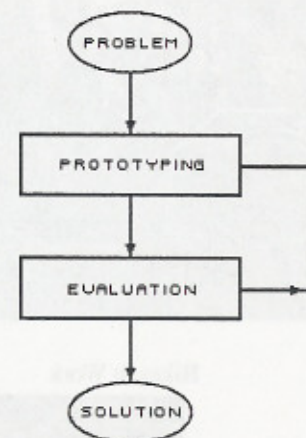



### To attach dropouts to the wheel wells and rib (bolt-together cart)

- 1) Slide the dropouts onto the wheel wells and ribs with the flat side of the plate facing towards where the wheels will be. The dropouts should be in front of the rib.
- 2) Line up the 4 dropouts using the same dropout jig from the brazed cart or with very accurate measuring.
- 3) Clamp the edge of one dropout with a C clamp and drill a 1/4" hole (first dent, then 1/8", then 1/4") through the dropout and 1/2" EMT tube. This hole needs to be accurate and close enough to the edge that another bolt will fit next to it. Once this hole is drilled, the dropout can't be moved.
- 4) Slide a 1 1/2" 1/4"-20, bolt through the plate and tube, and tighten with a lock washer and a nut.
- 5) Remove the clamp and drill another hole in the other edge of the dropout plate.
- 6) Tighten with another bolt/washer/nut combination.
- 7) Repeat 3-6 with the other 3 dropouts. The dropouts on the wheel wells will have slots going down. The dropouts on the rib will have horizontal slots.

### Making the pulling arm and attaching it to the frame (bolt-together cart)

- 1) From dowel or 2X4 lumber scraps, make six 2" long plugs of wood that just fit inside the 1 1/4" EMT. These will be plugs to keep the tube from collapsing when bolts are tightened through it.
- 2) Create an arm in the shape shown from 1 1/4" EMT and a 1 1/2" elbow. One bend is made with an elbow; the other is made by crimping the tube by hand in a vice. Where there is overlap, insert a wooden plug and drill through in 2 places. You will need one section of 1 1/4" EMT 11" long, and another 49" long.
- 3) Drill a 3/8" hole (first dent, then 1/8", then 3/8") vertically through the arm for the hitch bolt. Drill through a wooden plug here too. The hole should be 5/8" from the end of the tube.
- 4) Slide a 3/8"-16 bolt, 2" long, down through the hole, and tighten a nut onto the other side. Make this very tight. If the trailer arm is not parallel to the ground, remove this bolt and slide it UP through the hole, so the arm hangs from the hitch. It is not as secure going up, but it will work.
- 5) Put it all together, and place it on the cart so that when the bike is pulling the cart, the cart is centered on the bike and pulling straight. Mark where the pulling arm overlaps the spine and rib (3 places) and carefully drill 1/4" holes straight through the spine, rib, and pulling arm. You can drill them separately or together, as long as the holes line up. Before you bolt them together, slide wooden plugs into the tube and drill through. This is kind of tricky at the connection with the rib, and it is easier with two people working on it together.
- 6) Bolt through the spine and rib through the pulling arm with 3" bolts or bolts made from nuts and threaded rod.

### Making an easier pulling arm

Attach another rib positioned as far forward on the cart as possible. Use one 50" piece of 3/4" EMT, bent with a conduit bender (different size bender; a 3/4" conduit bender has a bend radius of 9"), to make a pulling arm like the arm for the brazed cart. Drill and bolt sideways through the arm into the two ribs. Wrap it tightly with strips of bicycle inner tubes.

### Finishing the bolt-together cart

Make a hitch like the one in the cyclecircus illustration or for the brazed cart. If you were to take the bolt-through hitch to a welder, it would only take 2 minutes to MIG weld it together. Add a plywood bed.

## **Using the cart**

I became interested in bike carts after I saw two Bikes at Work trailers being used for trash and recycling pickup in Northampton, Massachusetts, by Pedal People. They are great trailers, but cost \$400. This cart costs \$30 in parts, is fun and educational, and is an opportunity to build community through both the fabrication and use of the carts.

### Community cart programs:

I'm interested in supporting community bike cart programs. I've been involved in a community bike program at Hampshire College, which has Yellowbikes all around campus for anyone to use. We work on them once a week, which is an opportunity to learn bike maintenance skills, hang out with good people, and do something beneficial for the community while having fun.

I would like to see community bike cart programs with user accountability. Imagine this: a group of people get together, obtain some funding from the town for a community development project, and build a few bike carts. They advertise the program in the town/neighborhood, and offer the use of these carts to anyone. For a small deposit of money, barter equivalent, trust, etc, you get a key that unlocks the bike carts from wherever they are. You have designated locations where they live, where you might expect to find a cart. In this way, many people can use a few carts. The carts could either have designated bicycles, or you can attach the hitch to your bike when you get the cart. Or, you can build a hitch for your bike and leave it on all the time if you use the cart frequently.

### Weight capacity

Should I put a recommended load weight limit on the cart? I guess so. I've successfully carried 300 pounds of people in these carts. Once, with a 300 pound load, one wheel potato-chipped while going on a sandy slope sideways. It was fine on flat ground. So if you carry 300 pounds, don't take the cart on a sideways slope. The wheels are the weakest part of the cart. Maybe a 200 pound load limit?

### Fabrication time expectations

It takes me about 8 hours to make a cart. It takes 1 hour to make the hitch. 2 hours is aligning and brazing the frame together. 1 hour is cutting, bending, and mitering the tubes, and the other 4 hours are for dealing with wheels, painting the joints, making the plywood bed, and other small details. The first time you make a cart will take much longer...maybe 15 hours.

### How to load, how to pull

Balance the load just in front of the wheel axles, to keep a downward force on the hitch, but not too much. Try putting a lot of weight in the back as an experiment. It's not fun for long. Secure the load with straps, especially on bumpy roads. When pulling, don't go around corners too fast when the cart is empty, because it could flip over. Don't go around corners too fast when it's heavily loaded, because the sideways force on the wheels could cause them to buckle. Try not to jack-knife the trailer when backing up or taking sharp right turns because it could damage your bike or the hitch.



Don't let these suggestions keep you from inventing crazy ways to use bike carts.

**Some possibilities...**

- grocery shopping
- moving to a new home
- parade float
- critical mass bike ride
- bike transporter
- mobile renewable energy
- pickup truck alternative
- carrying manure
- spreading manure
- trash/recycling pickup
- grocery delivery
- furniture delivery
- pizza delivery
- newspaper delivery
- bicycle rickshaw service
- ice cream cart
- dumpster diving
- transporting huge glass doors
- funeral procession hearse
- picking up junked bikes
- moving rocks out of a garden
- carrying food to gatherings
- food pickups for survival centers
- ambulance in cities
- delivering medical supplies at protests
- moving food/waste/tools on a farm
- foraging...

**tools for fabrication**

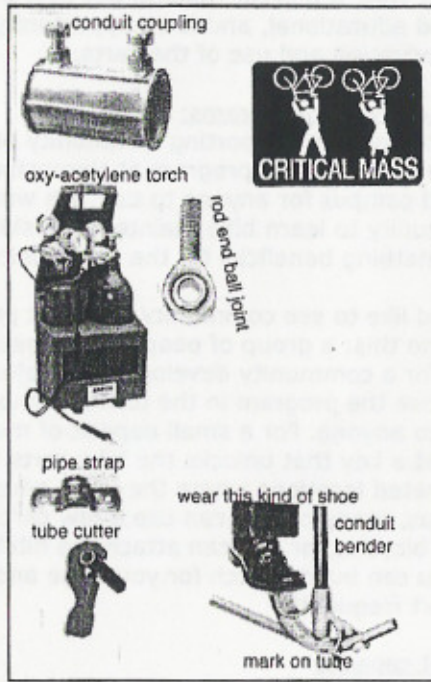

**Investing in an alternative to cars**

There is a significant amount of embodied energy and chemicals involved in the fabrication of these trailers. The steel industry has a long history of chemical pollution and labor exploitation. I don't know what's in brazing flux, or what the process of galvanization is like. Brazing conduit releases zinc oxide and other chemicals. The paint used to protect the joints is dangerous, and paint cans have a disposal problem. Recognizing all this, bicycle carts can replace a technology that is much more chemical, energy, and exploited-labor intensive: the automobile. The health benefits from transporting oneself by bike are significant. I encourage you to treat this project as an investment in an alternative to cars, and as such its usefulness will outweigh its social, environmental and financial costs.

**Cutting and bending tubes and dropouts (bolt-together cart)**

*From the first piece of 1/2" EMT(main frame)*

Mark and bend the main frame tube at 7", 43 1/16", 64 1/8", and 100 3/16". Mark but don't bend at 114 1/4". There is an overlap from 114 1/4" to 120".

*From the second piece of 1/2" EMT(two wheel wells)*

Cut 2 pieces 41 5/8" long. Mark at 4" from each end. Mark and bend at 4 1/2" from each end. These are the wheel wells.

*From the third piece of 1/2" EMT(rib and spine)*

Cut a piece 42 3/8" long. Mark at 4" from each end, and mark and bend at 7 1/4" from each end. This is the rib.

Cut a piece 60" long. Mark at 4" from one end. From that end (back end), mark and bend at 6 1/2", 43 1/16", and 52 5/8". This last bend at 52 5/8" is a bend away from the others, which makes a handle attachment.

*To make dropouts*

- 1) Bend the square outlet box covers over a piece of 1/2" EMT in a vice, to make a shape like a candy cane, so that the bend goes just over halfway around the EMT.
- 2) Cut the piece in half to make 2 short candy cane or "J" shapes when viewed from the end.
- 3) With a hacksaw, cut a slot in the middle of the flat section that is 3/8" wide and 3/4" long. Bend the metal between the cuts over with pliers and cut it off with a hacksaw. File it smooth.
- 4) Repeat 1-3 with the other outlet box cover. You will have 4 dropouts.

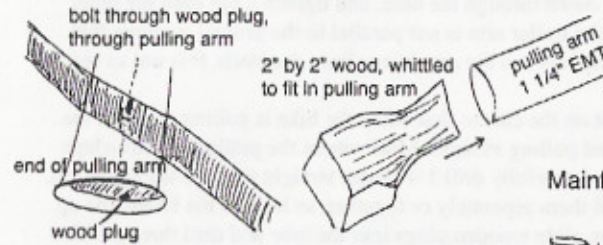

**Mainframe and Spine Connection**

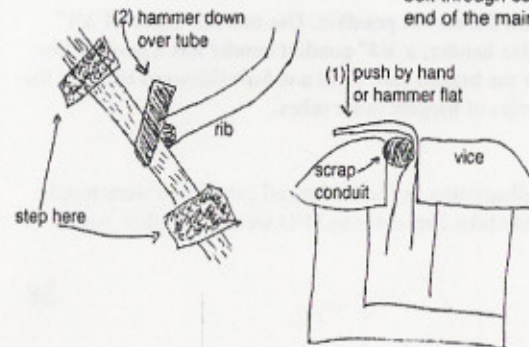
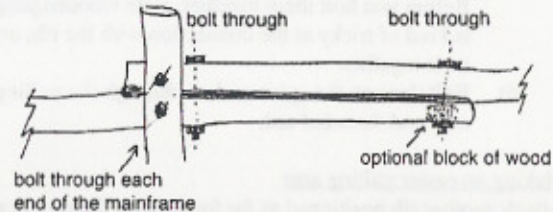



### Materials (bolt-together cart):

Total cost: \$37 for trailer body, and \$7 to \$10 for the hitch.

- |  |                |
|--|----------------|
| (3) pieces of 1/2" EMT                                     | (\$3 each)     |
| (2) 4" square metal outlet box covers                      | (\$1.09 each)  |
| (18) 1/4"-20 bolts, 1 1/4" long                            | (\$0.10 each)  |
| (14) 1/4"-20 bolts, 1 1/2" long                            | (\$0.11 each)  |
| (4) 1/4"-20 bolts, 1 3/4" long                             | (\$0.14 each)  |
| (44) 1/4"-20 nuts  | (\$0.05 each)  |
| (41) 1/4"-20 lock washers                                  | (\$0.05 each)  |
| either some 1/4"-20 threaded rod, or 3" long 1/4"-20 bolts | (\$0.21 each)  |
| a piece of 1 1/4" EMT (enough for 2 carts)                 | (\$20.2 carts) |
| 90 degree bend of 1 1/2" EMT                               | (\$7.00 each)  |
| (6) scrap dowel or wood, 1 1/4" diameter, 2" long          | (free)         |

### Tools:

- |                          |                        |
|--------------------------|------------------------|
| Drill (3/8" power drill) | (2) 7/16" wrenches     |
| 1/8" bit                 | flat file              |
| 1/4" bit                 | vice                   |
| 3/8" bit                 | hack saw               |
| tape measure             | tube cutter (optional) |
| marker                   | pliers                 |
| hammer                   | C-camp                 |
| nail/starting punch      | Safety glasses         |

### Bolted Joint with 4 bolts and bent conduit

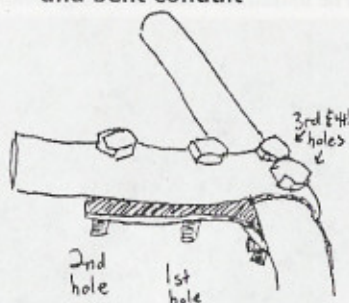

### To make a joint (bolt-together cart)

The following joint is used in all the connections between the wheel wells, ribs, spine, and main frame.

- 1) Hammer the last 4" of the tube flat so that the flat part can wrap around the main frame tube.
- 2) Place a short piece of 1/2" EMT on the ground perpendicular to the flattened piece, and wrap the flattened part over the other EMT. Hammer it into a tight fit.
- 3) Clamp the end of the overlap with a C-clamp, with a loop created around a short piece of conduit, and put it in a vice. Drill through the overlapping flattened piece into the tube on the other side, so that a bolt through that hole could clamp the joint together. To start the hole, tap the metal with a nail and hammer to make a dent. Drill first with a 1/8" bit, then enlarge to 1/4".
- 4) Slide a 1/4"-20, 1 1/4" long hex bolt through the hole. Slide a split-ring lock washer onto the end, and thread and tighten down a 1/4"-20 nut.
- 5) Repeat step 3 farther down the overlapping material. Take out the bolt from step 4 until the joint is in its final location.
- 6) Take out the short piece of conduit from the joint and wrap around the main frame. Insert two bolt-washer-nut assemblies through the holes in the joint and tighten.
- 7) If the joint isn't tight from the bolts, clamp with a C-clamp on the edge of the loop of flattened conduit.
- 8) Where the flattened conduit wraps around the main frame, drill a hole with a 1/8" bit, leaving room for another 1/4" hex bolts.
- 9) Enlarge the hole to 1/4".
- 10) Slide a 1/4"-20, 1 1/2" long bolt through the hole. Tighten onto a lock washer with a nut.
- 11) Take off the clamp and repeat 8-10 for the other side.

### Tools needed

The only tools which are not very common where I live are 1/2" conduit benders, half-round files, and oxy-acetylene torches. You'll also have to buy brazing rod and gas for the torch.

- |                                   |                                   |
|-----------------------------------|-----------------------------------|
| 1/2" conduit bender               | \$22                              |
| hack saw                          | common, or \$12                   |
| tape measure                      | common, or \$4                    |
| marker                            | common                            |
| punch (or nail)                   | common                            |
| hammer                            | common                            |
| vice                              | borrow, or \$40 for a small vice  |
| 1/8" bit and 3/8" bit             | common, or \$3 each               |
| drill                             | common, or \$80                   |
| half round file                   | \$10                              |
| oxy-acetylene torch               | borrow, or \$300                  |
| plentiful brass brazing rod       | \$5                               |
| brazing flux, goggles, and gloves | borrow, or \$10 for a lot of flux |
| bricks for holding frame          | common                            |
| framing square / "L" layout tool  | common                            |



summer, rebecca, dan, and lillian





**Materials and fabrication**

EMT Conduit

The kind of tubing used for the cart frame. It is used industrially to protect electrical wires. EMT stands for "Electrical Metallic Tubing." The nominal dimension is the inside dimension (ID). The outside dimension (OD) for 1/2" EMT is about 3/4".

Jig

A device to align the dropouts and hold them at the correct spacing.

Mild steel

A common carbon steel that is cheap and available from metal suppliers. Mild steel tubing is not nearly as easy to find or as cheap as EMT. 3/4" mild steel tubing has about the same OD (outside dimension) as 1/2" EMT. 3/4" mild steel with a 0.049" or 0.069" wall thickness costs \$1.50 per foot and weighs considerably more than EMT. In a test that I did with a spring scale, 1/2" EMT resists bending to 68% the force of 0.049" wall mild steel tubing, and costs \$0.30 per foot. The zinc oxide fumes it emits when heated are toxic, however. See the section on welding the frame.

Miter

A fitted connection between two pieces of metal. In this case, it is a 3/4" diameter half-circle cut out of the end of a tube.

**Parts (see page 8 for pictures)**

Coupling

An end-to-end connection for conduit. One is used on the main frame. Get a coupling that is steel, so it can be brazed. If you want to make a detachable pulling arm or pushing handle, you can use compression couplings.

Dropout

The slotted piece that holds the wheel axles.

Handle

Used for pushing the cart by hand. While it is not essential for the cart's operation as a bike trailer, it adds versatility.

Hitch

The connection between the bike and the pulling arm. There are 2 hitch styles. The *bolted hitch* is a piece of flat metal with an arm that hooks around the chainstay. There is a ball joint on the bottom of the hitch. The *clamp hitch* consists of two bent pieces of rod that are clamped together around the chainstay and seatstay with two bolts. The bolted hitch is easier to make and cheaper, and the clamp hitch is stronger and better adapted to bikes with quick release axles.

Main Frame

The rectangular piece that creates the rim around the bed of the cart.

**Bolt-together design**

And now something else entirely. I spent a lot of time trying to make a design that could be built without welding or brazing, because welding equipment is less common than a drill. The design works, but it's much harder to build because every connection must be drilled and bolted, instead of brazed or welded quickly. The structure of the frame is the same, except for the towing bar, which is underneath the frame, and is the most expensive part of the whole cart. It causes this cart to be not only more difficult to build than the brazed version, but to be more expensive as well. If you wanted a cheaper bolted version, you could do two things: replace the pulling arm with something made from 3/4" EMT or 2 pieces of 1/2" EMT bolted together. This would be easy and cheap. You could also modify the frame to be deeper, and use a pulling arm similar to the one on the welded frame. If I were to continue with this design, I would try to create a pulling arm underneath the frame that is made from 2 or even 3 pieces of 1/2" EMT (3 pieces in a pyramid).

The weakest part of this design is the dropouts, which makes it overkill to have such a strong pulling arm. Perhaps the dropouts could be strengthened with 2 overlapping plates, or just the dropouts could be brazed, in a similar configuration to the welded trailer dropout design.

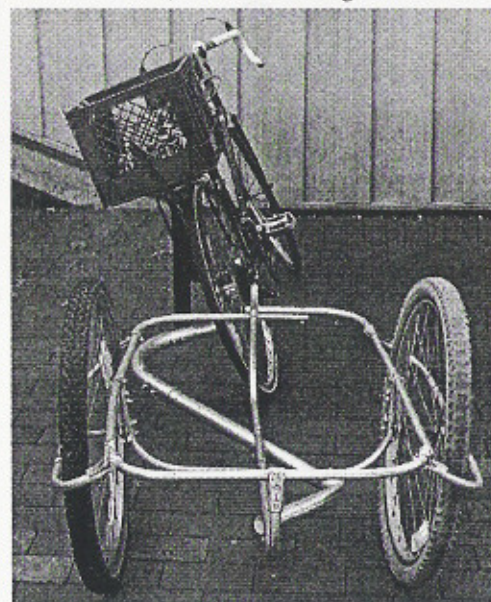

**rib / dropout connection**

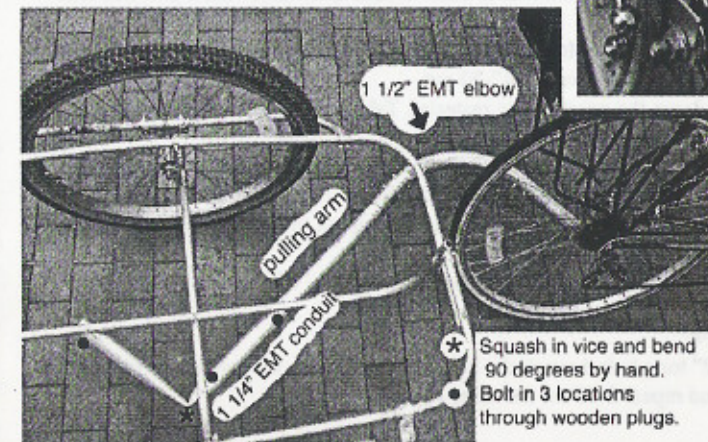
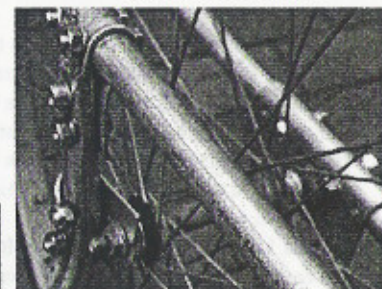
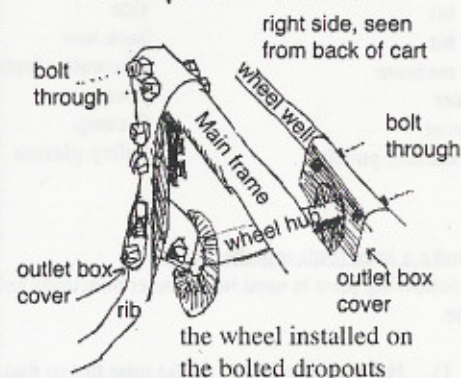



**Deep and Long Cart  
6 foot bed**

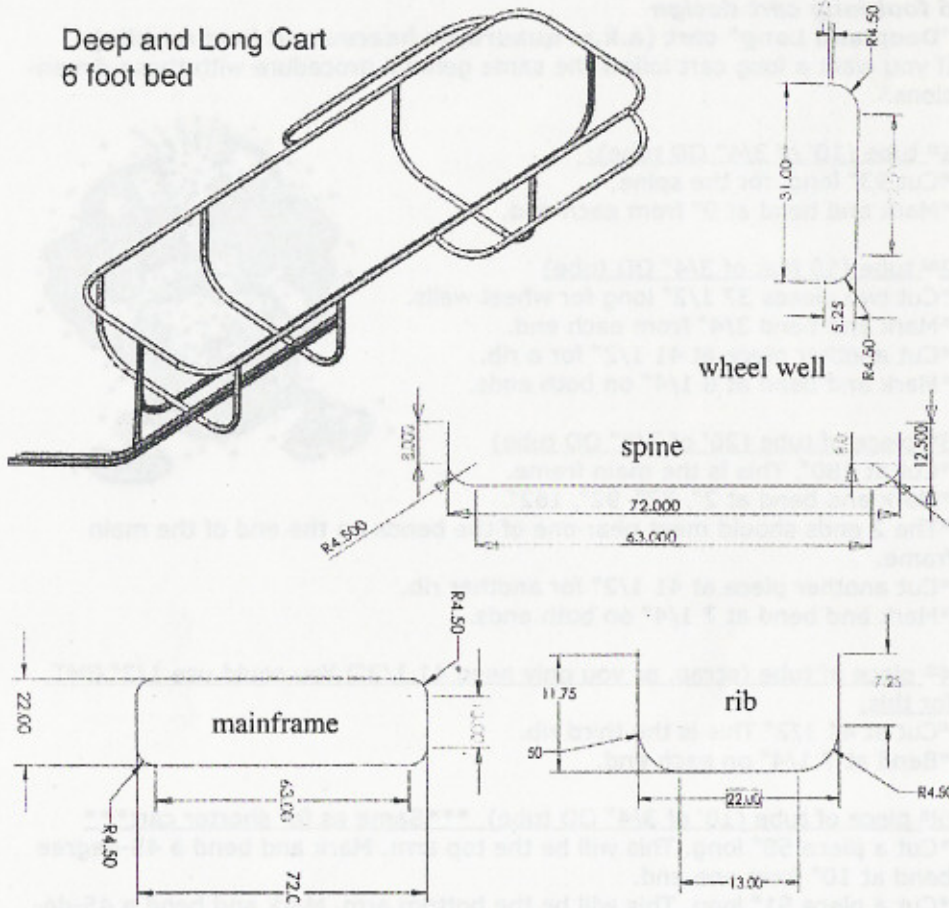

**Rib**

The three pieces that run sideways across the cart. The center rib holds the inside dropouts. The front rib braces the pulling arm. The rear rib provides structure for the bed and the handle.

**Rod-end Ball Joint**

A universal joint that spins freely around two axes and about 15 degrees in the third. It is used on the hitch to allow the bike to lean, turn, and go over bumps independently of the cart.

**Pulling arm**

The arm created by two "L" shaped tubes (bottom arm and top arm). The pulling arm attaches to the front two ribs and spine, and connects to the hitch on the bike.

**Spine**

The piece that runs from the front of the cart to the back, below the ribs.

**Brazing and welding**

**Brazing**

The process of heating metal and applying brass to join and fill in the gap between the two pieces of metal.

**Flux**

A paste that is used in brazing to help the filler metal flow into the joint. Get a non-toxic flux that can be cleaned up with water.

**MIG welding**

"Metal Inert Gas" welding creates a spark between a wire and the material, which melts both. A wire feed throws the metal into the area being welded. It's an easy form of welding to make a strong connection, but it's not pretty until the welder is very good. Gas MIG welders are expensive and more dangerous. This cart can be welded with a MIG setup. Consider using mild steel tubing instead of galvanized conduit.

**Oxy-Acetylene Welding/Cutting/Brazing torch**

Uses an oxygen tank and an acetylene tank with regulators to supply gas to a torch. Use a brazing or welding tip. Cheap oxy-acetylene torches can be bought on eBay for \$80 or so without the tanks, which you can rent. The cheapest setup with tanks is \$300. There are a lot of oxy-acetylene torches around. Check with farmers, automobile and equipment repair people, neighbors... If you find an arc welder that you want to use instead, seriously consider buying mild steel tubing instead of galvanized EMT, because of the fumes generated. You can also use an air-acetylene torch, about which I know nothing. Mapp gas and oxygen, which you can buy in cylinders at hardware stores, might also be hot enough...

donna picking up hay bales in deep and long

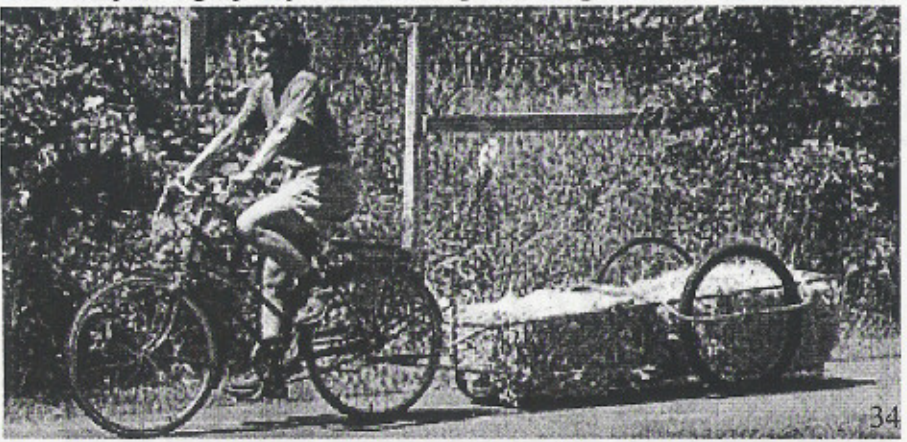

microcosm's evolution design

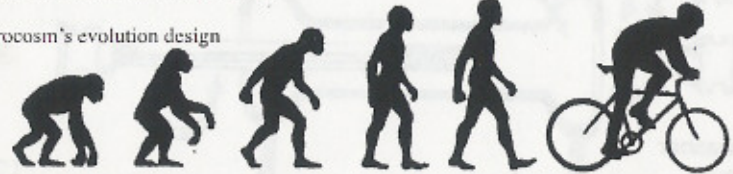



## Finding and Buying Parts

You can find a lot of the parts, particularly if you're near a metal dumpster or a building renovation that might be ripping out conduit. Metal shops often have scraps of flat stock that you might be able to take.

**Wheels:** Go with what you can find. Feel lucky if you have the option of mountain bike wheels over road bike wheels. The dimensions given here are for carts with 26", 27", or 700c wheels. If you use 24" wheels, you can reduce the cart depth by 1", and if you use 20" wheels reduce the dimensions by 3" (spine and ribs dimensions). 700c and 27" wheels work, but they're less strong, particularly laterally, which is important when you're hauling a load around corners.

Find wheels at bike shops or in the dumpsters out back. I've had good luck asking bike shops for old wheels, and in college metal recycling dumpsters. Try the dump or transfer center, yard sales, your garage, your neighbor's garage, your neighbor's friend's garage...wheels abound. Make sure you get 2 of the same diameter, with the diameters within 1/2" or so with the tires on. You can get tubes with small punctures behind bike shops.

Another wheel possibility: It's easiest to use 2 front wheels because they will have the same hub spacing. However, you can use a front wheel and a rear wheel if you make one of the wheel wells longer and increase the hub spacing for the rear wheel to 4 3/4", instead of 4". Or measure your wheels exactly.

Hardware stores carry the EMT conduit and hardware. You will save some money if you can find scrap 3/16" by 1" bar, plywood and 3/8" ID tubing. Try metal dumpsters, scrap bins at machine shops and mechanics' garages, etc.

In the store, hardware parts are generally cheaper in the bulk bins than in pre-packaged boxes. I can't find rod end ball joints anywhere except mail order (I've used McMaster-Carr). The shaft should be 1 1/4" or more, and have threads that are 3/8"-24 or 3/8"-16. (The 24 and 16 refer to threads per inch.) Get a nut to match the threads. The hole through the ball should be 3/8" wide. You can order it from mcmaster.com. It is part 6072K64 for the oil-impregnated bronze race with a chrome plated steel ball and right hand threads. It costs \$5.92 without shipping. I think shipping is \$3 or \$4. You might consider getting a welding respirator (\$12) from McMaster-Carr at the same time.

For plywood, ask at a lumber yard if they have scrap wood. Building renovations and construction also generate waste plywood that will work fine.

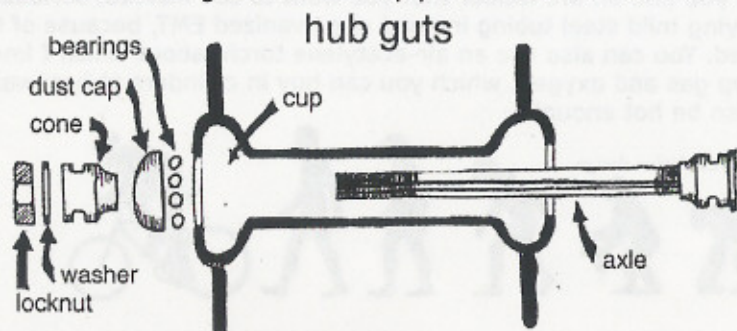

## 6 foot long cart design

### "Deep and Long" cart (a.k.a. quadruple hearse and love mobile)

If you want a long cart follow the same general procedure with these dimensions.

#### 1<sup>st</sup> tube (10' of 3/4" OD tube):

- \*Cut 93" long, for the spine.
- \*Mark and bend at 9" from each end.

#### 2<sup>nd</sup> tube (10 feet of 3/4" OD tube)

- \*Cut two pieces 37 1/2" long for wheel wells.
- \*Mark and bend 3/4" from each end.
- \*Cut another piece at 41 1/2" for a rib.
- \*Mark and bend at 8 1/4" on both ends.

#### 3<sup>rd</sup> piece of tube (20' of 3/4" OD tube)

- \*Cut at 180". This is the main frame.
- \*Mark and bend at 2", 72", 92", 162".
- \*The 2 ends should meet near one of the bends on the end of the main frame.
- \*Cut another piece at 41 1/2" for another rib.
- \*Mark and bend at 7 1/4" on both ends.

#### 4<sup>th</sup> piece of tube (scrap, or you only need 41 1/2") You could use 1/2" EMT for this.

- \*Cut at 41 1/2" This is the third rib.
- \*Bend at 7 1/4" on each end.

#### 5<sup>th</sup> piece of tube (10' of 3/4" OD tube) \*\*\*Same as for shorter cart\*\*\*

- \*Cut a piece 50" long. This will be the top arm. Mark and bend a 45-degree bend at 10" from one end.
- \*Cut a piece 51" long. This will be the bottom arm. Mark and bend a 45-degree bend at 11" from one end. Use a nail to make a guide hole 1/2" from the short end (11" before bend) as shown. One good hit with a hammer should be enough. Drill a 1/8" starter hole, and enlarge to 3/8". This hole should be as close to vertical as possible.
- \*Cut a piece 15" long. This will be the arm brace, and will be cut down more once the arm is on the cart.

This long cart, made from 1/2" EMT (for light loads) would require 60 feet of tube, costing \$18 for the tubing. If you make it from 3/4" OD mild steel, it will cost \$80 for just the tubing. The one I made had 3/4" mild steel tubing.





# Bicycle ambulances & trailers

Accessible transport solutions

From Hub and Spoke Sep 2003  
Reprinted with permission

When Niki Dun, final year student at the Emily Carr Institute of Art and Design, Vancouver, contacted Transaid last autumn asking for advice on the possibility of designing a bicycle ambulance for her graduation project, she probably did not foresee that 10 months later she would be in Malawi with her prototype. Richard Hanson, Programmes Manager, helped her with information on local operating conditions and availability of materials, together with useful contacts from Transaid's previous experience. The decision was then taken to get the design off the drawing board!

Niki is currently based at Lonje Metal Workshop, Salima, Malawi working with local artisans of the Salima Garage and Welders Association to finalise the design for production, testing and distribution of both the ambulance (essentially a stretcher on wheels to be towed behind a bicycle) and also a general purpose trailer version.

A significant part of the design brief is the use of locally available skills and materials. The aim of this project is to improve the effectiveness and efficiency of low cost intermediate transport resources in the community. Here we are looking at providing improved options at grass roots level - making transport available and accessible.

Two areas of specific concern to Transaid are the problems faced in getting urgent medical cases referred to primary health facilities and in the final distribution of food supplies (especially famine relief). In both cases the final few kilometres and time taken for delivery beyond the service centre or distribution point can make the difference between life and death.

The trailers will be trialled by the local bicycle taxi riders association as a simple low-tech, low-cost solution to local requirements for the carriage of



Roadtesting the trailer Transaid

goods - including the distribution of emergency food supplies in drought prone Salima District.

The ambulances will be allocated to Village Health Committees in rural areas to address the needs of those requiring transfer to distant health clinics where there are no motorised vehicles and the alternative may be walking or being carried by hand, by wheelbarrow or strapped to the carrier of a bicycle.

Transaid is working with local government and mission hospitals and the District Assembly's Directorate of Planning and Development to set up appropriate systems for the use and maintenance of the ambulances. We look forward to evaluating the progress made in what is essentially an experimental community development project.

Funding for this project appropriately came in part from the proceeds of the raffle held at the Commercial Motor Trailer of the Year Awards when more than £3,000 was raised. Niki's prototype bicycle ambulance was generously shipped to Malawi free of charges by Bob Risch and his team from TNT Canada.



Niki and her team in consultation Transaid

## Using the tools

To use a conduit bender, line up your bend mark with the arrow on the bender. Step on the foot plate, while pushing down and pulling sideways on the handle of the bender. Bend until the bubble level reads level with no force on the handle.

Working with metal in this project is easy, but takes some practice. To cut with a hacksaw, make sure the piece is clamped well and the cut is close to the clamp. Use the full length of the blade, pushing down hard enough to cut but not hard enough to bind the blade. Use steady, even strokes pushing forward. Don't press down hard on the return stroke. Hold both the back and front of the saw.

When using files, the cutting happens on the forward stroke. Pulling back with downward pressure on the file will only dull the file.

To cut with a tube cutter, align the mark with the cutting wheel and tighten the screw just enough to score the metal all the way around the tube. Tighten a little more and continue turning the tool, ensuring that the cut is in the original groove. Continue around the tube. This tool is useful for the conduit, but a hacksaw is more reliable.

To braze with an oxy-acetylene torch, it's a good idea to get a lesson from someone who knows how. Always set the regulator carefully and keep the tanks well secured so they could not fall. Use gloves, #5 shade eye protection, and work on non-combustible surfaces. Keep fire-extinguishing paraphernalia present. Work with good ventilation, especially with galvanized conduit.

To drill into metal, make a starting dent with a nail, and drill a small hole at high speed with a sharp metal bit. To enlarge it, use a lower speed and watch out for the bit catching as it breaks through the material. Always drill into material secured in a vice or by clamps.

General safety: Wear gloves when things are hot, don't wear gloves with spinning tools. Wear safety glasses when there are chips flying (drilling, cutting). Wear long non-synthetic, non-flammable clothes when working with the torch. Wear closed-toe shoes or boots. Don't breathe fumes from cutting, heating, or painting. Have fun and take care of yourself so you can ride your bike and pull your bike cart and tell your friends how great it is to not use a car.

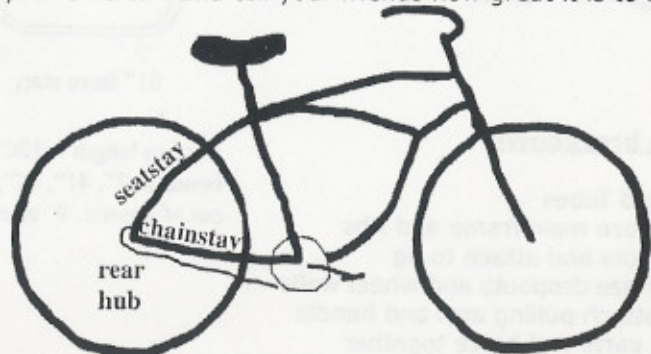



## Fabrication of the cart

### Cutting and bending tubes and dropouts

#### Main frame

From the first piece of 1/2" EMT (10' long)

\*This piece will be the **main frame**. With all tubes, make all marks before bending.

\*Mark at all the following lengths from one end before bending. Make a small star symbol at the starting end to signify "start bending from this side." Mark at 2", 41", 61", and 100".

\*Make a dotted line at 118". This will be the mark to which the tube overlaps when it is bent into a rectangle. Eventually, the last 2 inches will be cut off, but the tube is bent with the 2 inches to allow adjustment if the bends are uneven.

\*Bend 4 bends to make rectangular shape. With each bend, make sure that the previous bend is in the same plane. Line it up by eye, and fix mistakes by hand.

\*Holding the two ends of the tube in overlap of 2", measure the width of the frame at the front and back, before the bends. It should be around 22" or 22 1/2". If the front and back are unequal distances, you can cut off more or less than 2" from the end of the tube. Cut approximately 2" off the end of the tube. Bend the frame by hand so that the two mating tubes are in line with each other.

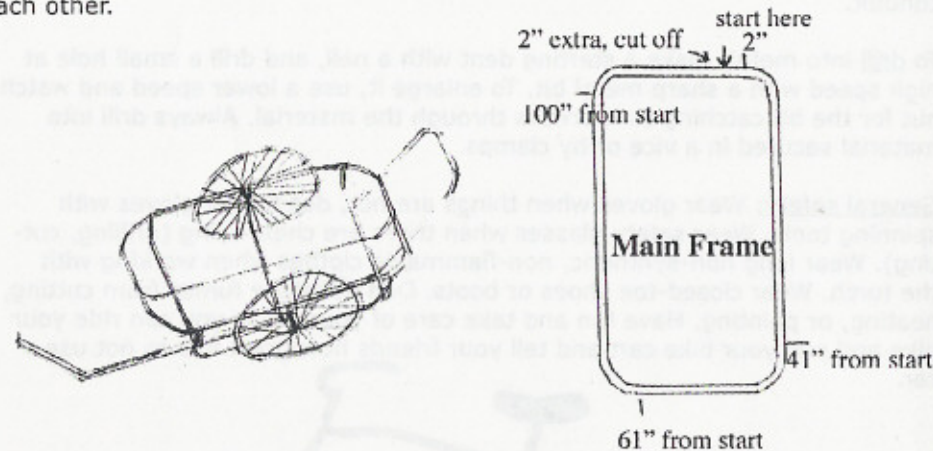

#### Fabrication breakdown

- \*Cut and Bend Tubes
- \*Align and braze main frame and ribs
- \*Make dropouts and attach to jig
- \*Align and braze dropouts and wheel wells
- \*Make and attach pulling arm and handle
- \*Make hitch parts and braze together
- \*Add plywood bed, wheels, and paint the joints

starting length = 120", or 10'  
bends at 2", 41", 61", and 100"  
cut of approx. 2" after bending

## Finishing the cart

\*Drill a 1/8" starter hole 1/2" from the end of the pulling arm, and enlarge to 3/8". This hole should be as close to vertical as possible.

\*Crush the end of the pulling arm slightly around the bolt hole so a 3/8" nut just slides inside. Slide a 2" long 3/8" bolt through the arm, from the top to the bottom, threaded through the bolt inside the arm. Slip a 3/8" split-ring lock washer on, and then thread another 3/8" nut onto the end of the bolt and tighten it until the tube is crushed around the interior nut. Thread one more 3/8" nut onto the bolt. Make it tight. Option: Braze the nuts and bolt together, and to the arm.

\*Take a 3/8" wing nut and braze a 2" long piece of scrap metal onto the two wings. Use some of the rod from the hitch, or whatever you find. This will be the nut that attaches the cart to the bike, and the wing nut extension allows removal without tools. (Alternative: use a 3/8" nut with a wrench.)

\*Attach the wheels to the cart. If there are quick release skewers, put the levers on the outside of the cart.

\*Paint the joints of the cart with an outdoor metal paint and/or primer. You don't need spray paint. Any anti-rust brush-on paint works. Paint the hitch too, but not the inside of the nuts (clamp hitch). Remove the ball joint before painting the hitch.

\*Add a bed. Use 1/2" plywood that is 19" by 38". Use any kind of clamp to attach the bed to the ribs. Plumbing or conduit clamps work. Sheet metal strips with punched holes are cheaper but more work. You could try plumbers' tape, screwing through the holes into the plywood. Cut slots in the plywood to fit the tubes where they curve. This part can be any kind of creative expression. Metal, driftwood, plastic, canvas, plywood, rope, glass...some ideas are better suited to certain applications.

\*Make tie-down straps out of old bicycle tubes, with the valve cut off. Use bowline knots to attach them to the main frame.

\*A nice option: Add something unique and special to the cart. My personal favorite is a pole with space for art and signs. "One less car" "Yes, I'm moving by bike" "One less car; make it two?"

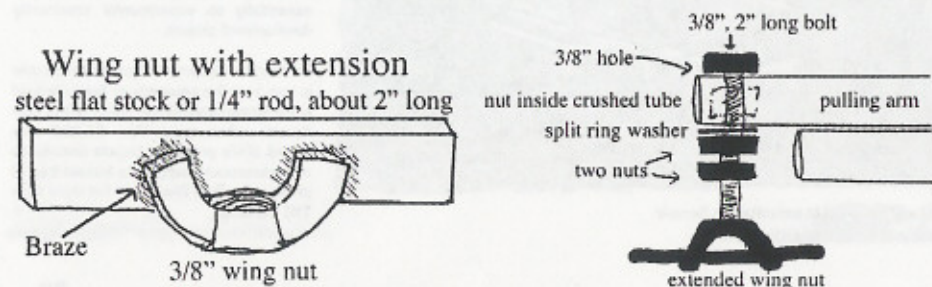



\*Get a 3/8" threaded female coupler from a hardware store. It will probably be 1 3/4" long. Holding it firmly in a vice, drill out the threads with a 3/8" drill bit. If you have bits close in size to 3/8", start smaller and increase the dimension. If you don't, be really careful doing this part because the bit can grab the metal and twist the drill forcefully. Cut its length in half with a hacksaw. File smooth. This tube will hold the ball joint loosely so it can turn freely. Alternative: cut a 7/8" long piece of tubing that has a 3/8" ID.

\*Place the hitch plate on a flat surface so that the end with the slot is sticking up.

\*Line up the tube along the angle of the hitch plate, so that the ball joint sticking out of the end could rotate freely. Make sure that there is enough room for a 3/8" nut (which has a 1/2" head) to spin freely at the end of the tube. This needs to be very strong.

\*Cut a piece of 1/4" or 5/16" rod that is 8 inches long. Bend the end in the shape shown in the diagrams (a hook to go around the chainstay).

\*Brazed the rod onto the opposite side of the hitch plate, so that the straight end runs at the same angle as the cut, making sure that it does not hang over the edge of the cut. See diagram for details.

\*Put the hitch on a bike through the left side axle. Loosely tighten the axle nut. With a vice, hammer, pliers, or your hands, bend the rod until it fits well on the chainstay and meets the rest of the hitch. The 3/8" ID tube needs to be parallel to the ground and the hooked arm should rest on the chainstay without interfering with the spokes of the wheel.

\*File everything smooth. Paint the hitch. Once dry, attach the rod end ball joint through the tube, and secure it with a nylon nut. Make sure the ball joint can spin freely without play.

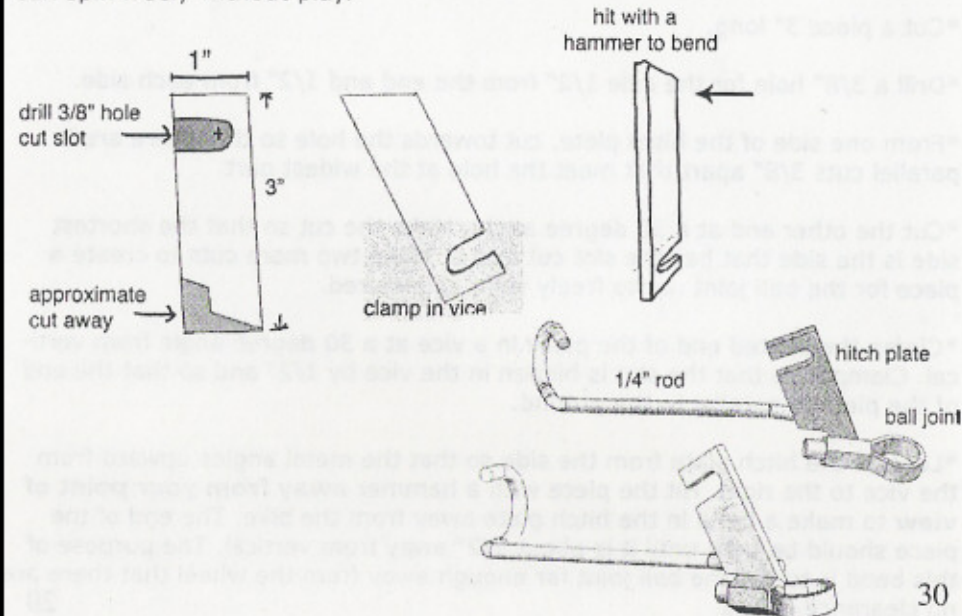

### Spine and one Rib

From the second piece of 1/2" EMT (10' long)

\*Cut a piece 59" long, which will be the **spine**. Cut a piece 38 1/2" long, which will be one of the two **ribs**.

\*Mark the **spine** at 6 1/2" from each end.

\*Bend from each end to create a wide "U" shape, as shown.

\*Mark the **rib** at 5 3/4" from each end.

\*Bend from each end to make another "U" shape, as shown.

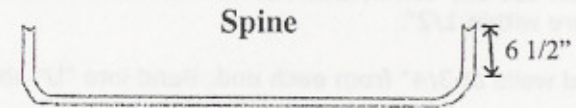

starting length: 59"  
bends at 6 1/2" from each end

diagrams are not drawn to scale

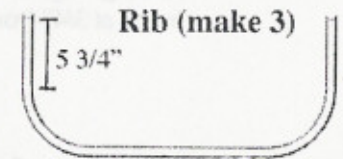

starting length: 38 1/2"  
bends at 5 3/4" from each end





### One rib and two wheel wells

From the third piece of 1/2" EMT (10' long)

\*Cut another piece 38 1/2" long, which will be the second **rib**. Mark and bend this rib like the first.

\*Cut two pieces 38 1/2" long, which will be the two **wheel wells**.

\*\*\*NOTE: If you are going to be using rear wheels for the cart, and don't want to take out the spacers (with hub adjustment), you should add 1 inch to the length of the wheel wells, and cut at 39 1/2" If you don't add length, but use the wider rear hubs, the wheel wells will have less of a slope downward and will be a little weaker. (To visualize this, think about the wheel wells as a part of a structural triangle, from the back of the bike cart looking forward.) You can use any combination of front and rear wheels as long as the diameters are within 1/2".

\*Mark the wheel wells at 3/4" from each end. Bend into "U" shapes, as shown.

\*\*\*Note again. If you added an inch to the wheel wells above, mark the wheel wells 1 1/4" from each end.

### Wheel well (make 2)

3/4"

starting length: 38 1/2"  
bends at 3/4" from each end



Aaron pulling a  
55 gallon barrel

### Hitch creation

diagrams on following page

The hitch is made from flat stock, a short tube, a rod, a ball joint, and a nut.

It clamps onto the left side of the rear axle. There is a slot cut for the wheel's axle, a tube or drilled-out female coupler to allow the ball joint to pivot, and a rod that is braced against the chainstay to keep the hitch from twisting around the axle.

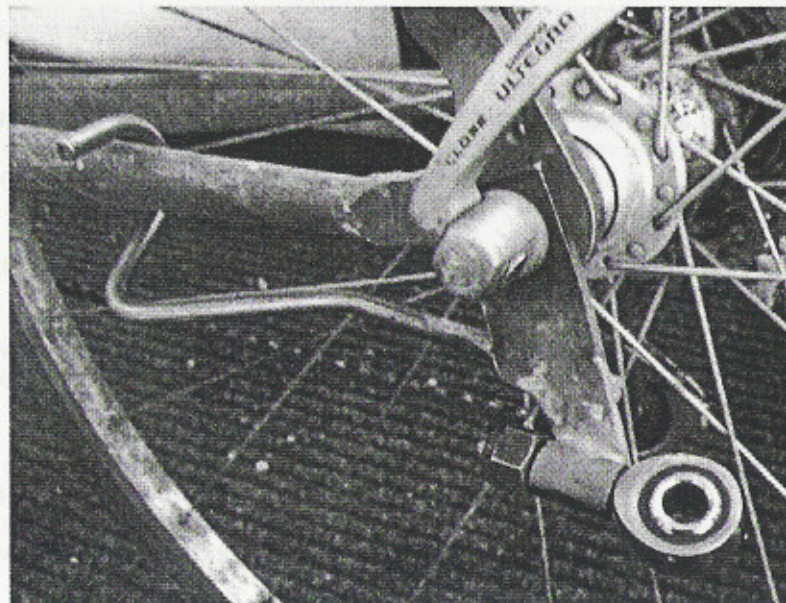

\*Start with a piece of the 1" X 3/16" flat stock that you used for the dropout jigs. This will be the **hitch plate**.

\*Cut a piece 3" long.

\*Drill a 3/8" hole for the axle 1/2" from the end and 1/2" from each side.

\*From one side of the hitch plate, cut towards the hole so that there are 2 parallel cuts 3/8" apart that meet the hole at the widest part.

\*Cut the other end at a 30 degree angle. Make the cut so that the shortest side is the side that has the slot cut into it. Make two more cuts to create a place for the ball joint nut to freely spin, as pictured.

\*Clamp the slotted end of the piece in a vice at a 30 degree angle from vertical. Clamp it so that the slot is hidden in the vice by 1/2" and so that the end of the piece is parallel to the ground.

\*Look at the hitch plate from the side so that the metal angles upward from the vice to the right. Hit the piece with a hammer **away from your point of view** to make a bend in the hitch plate away from the bike. The end of the piece should be bent until it is about 1/2" away from vertical. The purpose of this bend is to get the ball joint far enough away from the wheel that there are no clearance issues.



### Creating the pulling arm

\*Line up the top and bottom arms together on a flat surface with the longer piece, with the hole in it, on the top. Make sure the pieces line up on the long straight side and at the bend. If they don't, bend them until they do. The arm should look like a backwards "L".

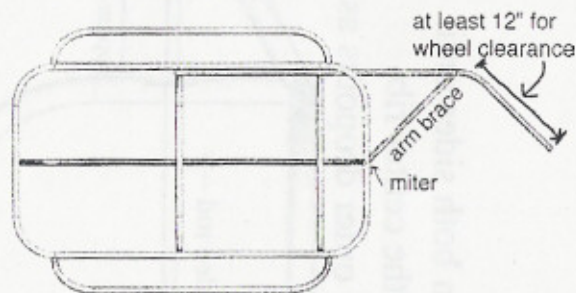

\*Coat 2" sections of the tubes with flux at 8" intervals (or so) and braze the tubes together. Make it strong enough to be stiff but not overkill. Braze on both sides of the tubes.

\*Let arm cool or dip in water. Place the cart on a flat surface with blocks under the ribs to keep them parallel to the ground. (The same position for brazing the wheel wells and dropouts.)

\*Support the arm with three piles of bricks/scrap metal so that the top of it is 1" below the bottom of the dropout on the center rib. This should be about 4 1/2" down from the main frame tube. If you are not using 26", 700c, or 27" wheels for the trailer, or if you are not going to make the trailer for a bike with a rear wheel of those sizes, you will want to adjust this dimension. The goal is to have this arm be parallel to the ground and meet the bike 2 inches under the rear axle. The bottom of the trailer should be at least 4" above the ground.

\*Flux and braze the arm to the front and center ribs at the same height. This braze needs to be very strong.

\*Measure the distance from the point just before the bend in the arm to the front of the spine at the same height. Cut the arm brace to fit here, ensuring that it intersects the arm at least 14 inches from the hole in the arm, and that the angled cut is aligned so that the mitered side fits the spine, and the angle has a decent fit with the arm. Again, accuracy is not that crucial. It just needs to be strong.

\*If you want to pull seriously heavy loads, you could make this whole arm out of 3/4" EMT (1" OD), and/or add another arm brace from the main frame down to the arm. You could alternatively use the thicker 3/4" mild steel tubing so you could use the same bender and dimensions for the parts. I've tested a single 3/4" mild steel pulling arm while pulling 400 pounds. With that much weight, everything gets a little wobbly, especially the wheels, but it all held together solidly around corners and over bumps.

### Pulling arm

From the fourth piece of 1/2" EMT (10' long)

Note: If you want to make a very stiff pulling arm for the cart, use 3/4" EMT, which has an OD of 1". You'll have to get a different bender, which has a bend radius of 9" instead of 4 1/2". Adjust tube lengths accordingly. If you are planning on carrying decent loads (200 lbs or so) and don't need a super-stiff connection, continue with 1/2" EMT because it's easier, cheaper, and the dimensions are all here.

\*Cut a piece 50" long. This will be the **bottom arm**. Mark and bend a **45-degree bend** at 10" from one end.

\*Cut a piece 51" long. This will be the **top arm**. Mark and bend a **45-degree bend** at 11" from one end.

\*Cut a piece 15" long. This will be the arm brace, and will be cut down more once the arm is on the cart.

### Pulling arm

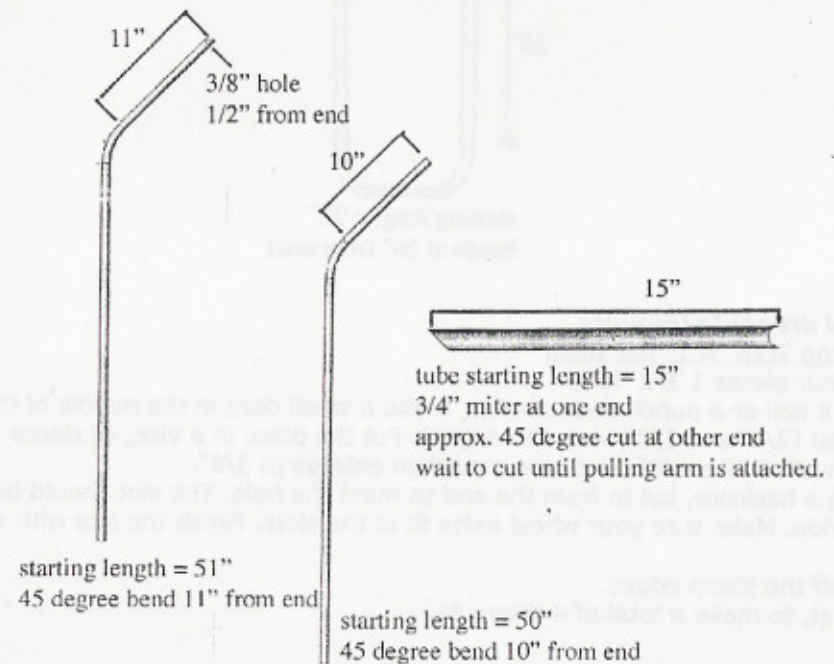

starting length = 51"

45 degree bend 11" from end

starting length = 50"

45 degree bend 10" from end





### Handle and third rib

From an optional fifth piece of 1/2" EMT

If you don't want a handle, you can save some time and money by skipping the fifth piece which makes an optional third rib and the handle. The handle adds quite a bit of versatility and usability to the cart.

\*Cut a third **rib** that is 38 1/2" long. This is a nice piece for easy attachment of the bed, but is not necessary structurally. Bend at 5 3/4" from each end. Position it where it fits at the back of the cart, mitered where it connects to the main frame and in contact with the spine.

\*Cut a piece 72" long. This will be the **handle**. Mark and bend the handle 26" from each end into a "U" shape. Make sure that the angles are 90 degrees at each bend, or the cart will have a visibly crooked handle.

#### Handle

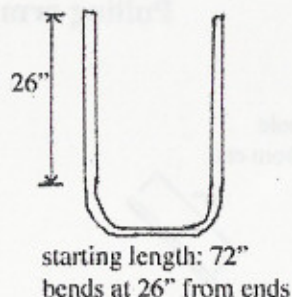

### Wheel dropouts/mounts

From the 3/16" X 1" flat stock

\*Cut four pieces 1 1/2" long.

\*With a nail or a punch and hammer, make a small dent in the middle of the material (3/4" and 1/2" from the edges). Put the piece in a vice, or clamp it really well. Drill a 1/8" pilot hole, and then enlarge to 3/8".

\*Using a hacksaw, cut in from the end to meet the hole. The slot should be 3/8" wide. Make sure your wheel axles fit in the slots. Finish the slot with a file.

\*File off the sharp edges.

\*Repeat, to make a total of 4 dropouts.

#### Axle dropout (make 4)

Use 3/16" by 1" flat stock

Cut 4 pieces, 1 1/2" long

Drill 1/8" pilot holes in centers

Enlarge holes to 3/8" diameter

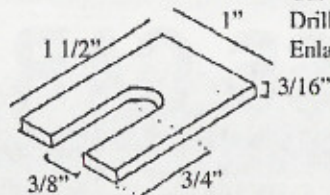

### Dropout jig alignment

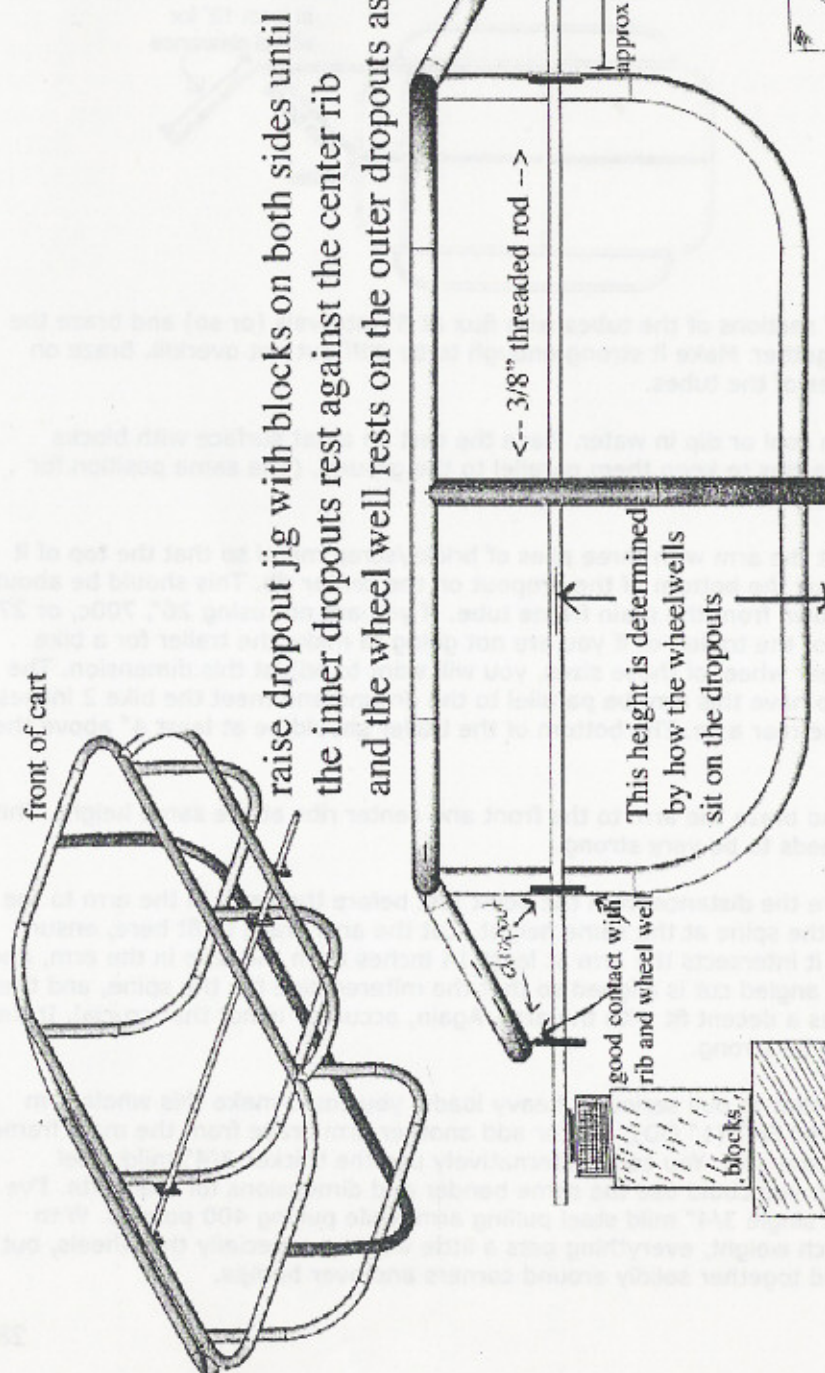



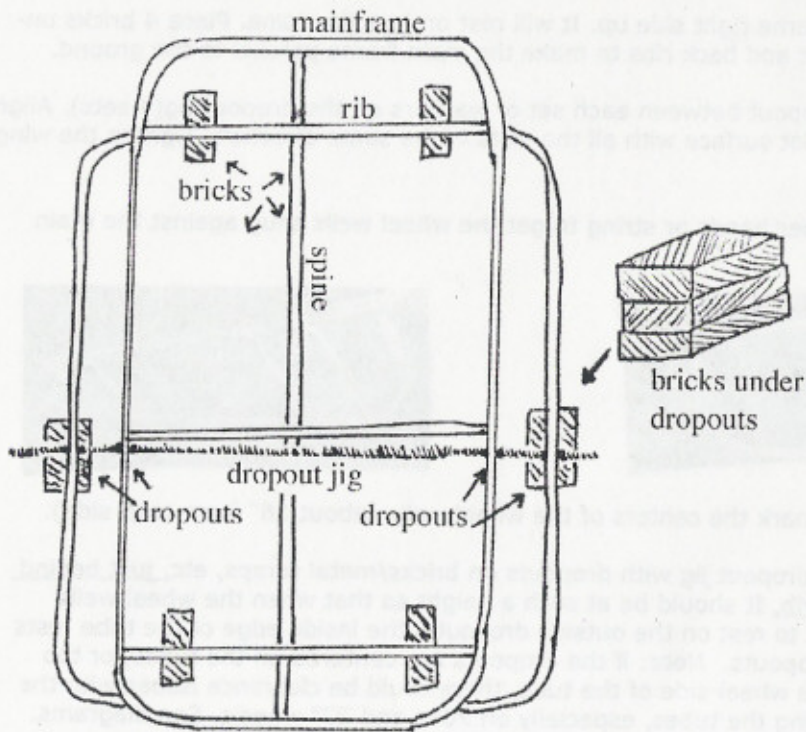

**Braze Order**

- 1) braze ribs and spine to main frame
- 2) tack ends of wheel wells
- 3) tack dropouts, remove jig
- 4) finish brazing wheel wells and dropouts
- 5) braze pulling arm pieces together
- 6) braze pulling arm to front and center ribs



new patch design

**Mitering the tubes for brazing/welding**

Mitering fits the end of one tube with the side of another, to make brazing strong and easy. Miter with half round file or hole saw that makes a 3/4" miter. (Optional step: With a file, hold the tube in a vice close to the end, and notch a "V" shape in the center of the tube with a square file or hack saw.) File the tube end until there is a good fit between the miter and another piece of tubing.

Note: make sure the miters go the right direction and are in parallel or perpendicular planes to the rest of the tube.

Each miter should only take about a minute. If it takes longer, use stronger strokes (pushing forward only).

To determine which direction to miter, refer to the image of the assembled cart, or below.

- \*Miter the **wheel wells**, cutting parallel to the bottom of the "U".
- \*Miter the **ribs** cutting perpendicular to the tube (opposite from wheel wells).
- \*Miter the ends of the **spine**, cutting perpendicular to the tube.
- \*Miter one end of the **arm brace**. The other end will be cut straight at an angle later.
- \*Miter the **handle**, cutting parallel to the bottom of the "U".

Start with a practice miter to join two pieces of tubing as shown. Practice brazing them together.

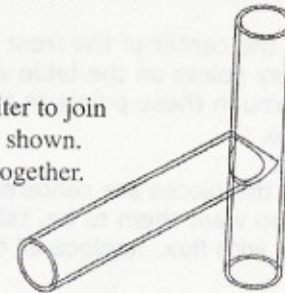

Ingrid fitting a modified bicycle trailer to a wheelchair





### Aligning the frame for brazing/welding

The first brazes attach the ribs and spine to the main frame. The cart is upside down for this part.

\*Place the main frame on a flat fire-proof surface. Paint flux on the ends of the tubes and inside of the coupling, and slip the two tubes inside the coupling as far as they will go, ensuring that there is flux at the edge of the joint. If the tubes spring back out, bend them in.

\*Measure 19" from the back end of the main frame. Use a square to get even measures on each side of the frame. Mark on the side of the tube, so the mark is visible when a tube is placed on top.

\*Place one of the ribs between the two marks. Check to see if the miters fit well. If the tube does not fit, bend by hand until it does. Support this rib with bricks, magnets, or other metal scraps, but not right in the center, where the spine will be.

\*Mark for the front rib 16 1/2" in front of the marks for the center rib. This positioning is not exact, but should be right where the bends start on the main frame. The front rib needs to stay out of the way of the wheel well. Adjust to fit, and support this rib as well. Do the same for the back rib.

\*Mark the center of the front and back ends of the main frame by marking half-way points on the table where the sides are parallel, then by drawing a line through those points to the main frame end pieces. Lay the spine over the ribs.

\*Once the pieces are centered, vertical, aligned, plumb, flush, or otherwise how you want them to be, take them all off and coat each surface that will be brazed with flux. Replace all the pieces.

\*Read the brazing information on the following pages. Braze the frame together, starting with the ribs. If the spine does not sit perfectly on the ribs, tilt the ribs towards the curve of the spine until there is contact, or bend the spine down to make contact.



### Adding wheel wells and dropouts -Diagrams on the following pages

\*Turn the frame right side up. It will rest on just the spine. Place 4 bricks under the front and back ribs to make the main frame parallel to the ground.

\*Place a dropout between each set of washers on the dropout jig(4 sets). Align them on a flat surface with all the slots in the same direction. Tighten the wing nuts.

\*Use 4 rubber bands or string to get the wheel wells snug against the main frame.

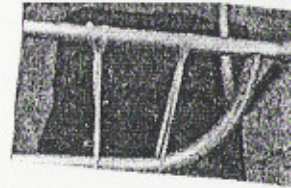

\*Find and mark the centers of the wheel wells (about 16" from each side).

\*Place the dropout jig with dropouts on bricks/metal scraps, etc. just behind the center rib. It should be at such a height so that when the wheel wells come down to rest on the outside dropouts, the inside edge of the tube rests with the dropouts. Note: if the dropouts are centered on the tubes, or too far from the wheel-side of the tube, there could be clearance issues with the spokes hitting the tubes, especially on 700c and 27" wheels. See diagrams.

\*When everything is aligned nicely, apply flux, and braze the wheel wells onto the main frame.

\*Make a small tack braze on each dropout. Remove the jig before brazing the dropouts completely, or the nylon in the washers will melt or the nuts could get brazed to the dropouts. Brazing the dropouts to the rib will require much more heat than brazing two tubes together because of the wall thickness. To keep from burning through the tubes, aim the flame mostly at the dropout.

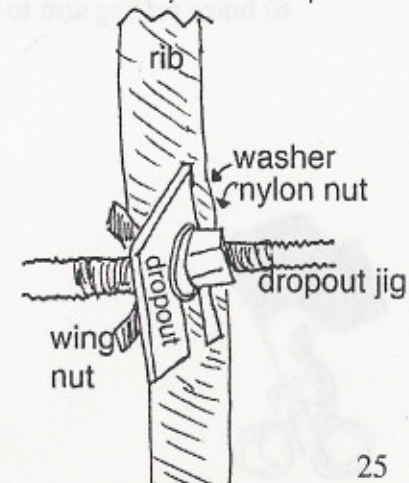



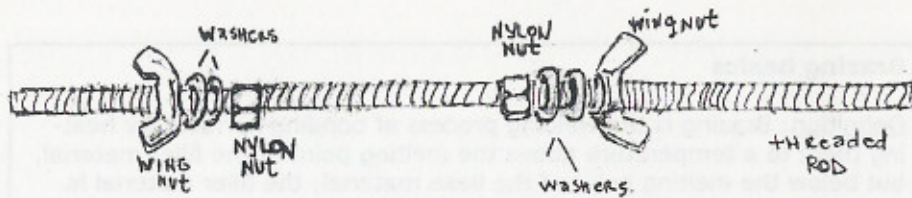

### Creating the dropout jig

*Note: These measurements assume that you are using 2 front wheels from bikes, with 4" distance between the outside surfaces of the locknuts. If you are using rear hubs or hubs with a different spacing make an appropriate adjustment in the jig.*

*\*If you are lucky enough to find 20" wheels, measure the axle width, adjust the dropout jig, make the wheel wells shorter by 6 inches or so, and take off 3 inches off of each side of the ribs and spine to keep the same clearance. (Axle height on a 26" wheel is 13", and on a 20" wheel it's 10".) If your wheels are strong, the cart with 20" wheels should be more stable and stronger than a cart with larger wheels. Move the wheel wells and center rib back by 6 inches to stabilize the cart.*

If you are going to be making several trailers, I suggest using nylon nuts for this jig. If you are making just one trailer, you could make a cheaper jig from wood or metal rod. As an alternative to nylon nuts, use 2 regular nuts tightened together.

\*Measure the width of the center rib from the outside of the one mitered end to the outside of the other end. Center to center will be about 22", and outside to outside will be about 22 3/4". Take your measurement, and subtract 1/4" (to allow the dropouts to sit well against the tube). It will be about 22 1/2".

\*Thread on a wing nut on each side, with the flat side of the nut facing out. Slide on two 3/8" washers on each side.

\*Thread 2 nylon nuts onto the threaded rod, one from each end. (The side without the nylon has to go on first.) To hold the rod while threading, you can thread two regular nuts onto the opposite end of the rod and tighten them together. Hold this end in a vice or another wrench.

\*Thread the first nylon nut 6" onto the end of the rod. Thread the other nylon nut on the other far enough so the distance from the outside of the two washers is the same as the distance measured along the center rib, minus 1/4" (see above, probably 22 1/2" or so).

\*Thread another nylon nut onto each side, so that the distance between the two nylon nuts and two of the washers is the same as the spacing for your wheels. For 26" mountain bike wheels, this distance is 4". For road bike wheels, the distance may be less, down to 3 7/8". If you're using rear wheels, it might be 4 3/4" or more.

\*Slide on two more washers on each side. Thread on one more wing nut on each side, so that the flat sides of the nuts are facing the washers.

### Brazing/welding frame together

#### Safety Considerations:

Ventilation  
Respiratory protection  
Eye Protection  
Heat Protection

#### Danger of welding galvanized metal (from cutting, welding, and brazing)

You are heating galvanized metal, which is coated in zinc. The zinc will burn off and oxidize in the air, creating zinc oxide. Breathing zinc oxide can cause Metal Fume Fever. According to the American Welding Society, Metal Fume Fever causes flu-like symptoms including headache, fever, chills, muscle aches, thirst, nausea, vomiting, chest soreness, fatigue, gastrointestinal pain, weakness, and tiredness. Symptoms start several hours after exposure and last 6 to 24 hours. The American Welding Society claims that there are no known long-term effects from Metal Fume Fever.

#### Ventilation:

- \*Braze outside. Portability is one nice thing about oxy-acetylene torches.
- \*Keep air moving across the work, with a fan or align yourself with wind so that the smoke blows sideways. (If your back is to the wind, your body will stop the airflow in front of your face.)
- \*Don't breathe the smoke plume.
- \*Keep your head back from and never above the area that you are brazing.
- \*Watch the ends of tubes, because fumes will escape from them.

#### Respiratory Protection:

If you cannot ensure adequate ventilation, wear an N95 (or higher) type respirator. You can buy a N99 filter respirator from McMaster-Carr for \$11.34 (Part #53565T2). The instructions say it's good for 8 hours of breathing through, or until it gets hard to breathe through. 2 replacement filters are \$5.61. I don't like buying from large mail-order corporations, but if the trad-eoff is getting sick or not building a bike cart, I will do it.

#### Eye protection:

Use #5 shade eye protection. If you look at the flame for a second, you're not going to lose your sight, but it's bright and bad for your eyes, a bit worse than looking at the sun. I've heard that you're eyes are safe 10 feet back from the flame.

#### Heat Protection:

Use gloves to touch the metal that you are working on. The brazing rod will get hot close to the end.



## Metal Fume Fever Information

According to the American Welding Society, Metal Fume Fever is an illness caused by exposure to zinc oxide, a chemical present in fumes from welding and brazing galvanized metal. The symptoms of metal fume fever are flu-like, including headache, nausea, fever, fatigue, and chills. Symptoms start several hours after exposure and last 6 to 24 hours, although total recovery might not be for 48 hours. High levels of exposure may cause metallic taste in mouth, dry and irritated throat, and coughing. Several hours after exposure, you may have a fever (lower than 102 degrees F, then chills before returning to normal). The OSHA standard for zinc oxide exposure is 5 milligrams per cubic meter of air averaged over an 8 hour work shift. NIOSH uses the same 5 mg per m<sup>3</sup> (cubic meter), but suggests that it is permissible for 10 hours per day, or 40 hours per week. They further permit a STEL (short term exposure limit) of 10 mg/m<sup>3</sup> averaged over a 15 minute period. There is no published information about long term effects of zinc oxide exposure. (American Welding Society. Safety and Health Fact Sheet No. 25)

Even though there are no known long term effects, it doesn't make sense to expose yourself to zinc oxide and potentially suffer from Metal Fume Fever, because it's easy to prevent exposure. Brazing, as opposed to welding, produces fewer fumes because of the lower temperatures.

### Protect yourself from exposure.

- \*Keep your head back from the fumes.
- \*Wear a particle respirator with a good face seal. There is a N99 filter from McMaster-Carr for \$12.
- \*Use a mechanical ventilation system that keeps the fumes out of your breathing zone.
- \*If you have an exhaust fan, position the duct intake next to your work to capture all the fumes.
- \*If you have a fan to blow across your work, make sure the air flows sideways in front of you so that your body does not interfere with the air flow.

In the process of designing and learning to build bike trailers with galvanized conduit, I got metal fume fever twice, through carelessness. You should be careful, and I think it is possible to braze EMT conduit safely. The sickness felt like the head and body ache that are symptoms of influenza. I felt dehydrated and tired. I felt fine the next morning.

## Brazing basics

Definition: Brazing is the welding process of bonding surfaces by heating them to a temperature above the melting point of the filler material, but below the melting point of the base material; the filler material is drawn into the joint through capillary action.

To braze a joint, heat up both metal surfaces to a temperature hot enough to melt the filler material (usually brass). Brazing is used to join similar or dissimilar metals with a filler material that bonds to both surfaces. Brazing is more effective than welding for galvanized steel because it minimizes zinc fumes and burning of the zinc coating. Additionally, brazing rods are usually compatible with zinc, thereby facilitating a good joint.

### How to braze:

Put on gloves and number 5 shade goggles. There should be good ventilation. Consider using a particle respirator.

Turn on your oxy-acetylene torch setup. First close the torch valves and make sure the regulators are disengaged (counter clockwise). Open the fuel (acetylene) tank valve 1 turn, while looking away. Usually, you will set the regulator to 10 psig. Open the oxygen valve all the way, and set the regulator to 10 psig. Bleed the gasses out of the torch handle by opening and closing the acetylene, then the oxygen valves. Open the fuel valve on the torch handle, and light it with a flint striker. Adjust the flame so that it almost creates a gap (without a flame) right at the tip of the torch. It is too low if it produces a lot of smoke. Add oxygen until the two visible flame cones come close together. For fine work, you will want the cones to merge. For general heating, keep them separate.

Coat the surface to be brazed with a brazing flux. Heat the two base materials with the flame, just beyond the inner cone. When the metal starts to shimmer a little, touch the brazing rod to the hot metal (don't melt it in the flame). The filler rod will flow into the joint. If the metal is too hot it will spark. If it is not hot enough the rod won't melt. Go all the way around the tube, creating a good fillet. The strength of the joint comes from the surfaces joined in close contact with brass and from the fillet (smoothed-out corner) between the base materials.

**DO NOT BREATHE THE FUMES FROM BRAZING GALVANIZED METAL (EMT conduit).** Use good ventilation and a welding respirator.

Turn off the torch by first closing the fuel valve on the torch handle. Then close the oxygen valve on the torch handle. Close the valves on the tanks, and open the torch valves to bleed the lines. Unscrew the regulators until they are loose. Close the valves on the torch handle.